



YALE UNIVERSITY
DEPARTMENT OF LINGUISTICS

Topics in Tlingit Ergativity

Joseph Class

Advisor: Jim Wood

May 2021

Submitted to the faculty of the Department of Linguistics in partial fulfillment of the requirements for the degree of Bachelor of Arts

Abstract

This work explores several different topics related to the syntax of ergative-absolutive case alignment in the Tlingit language, specifically looking into the case properties of both verbal pronominal markers and nominal elements. Because of the limited set of data available, and the as-of-yet unclear syntactic nature of verbal pronominal markers, I offer several potential analyses for most topics, none of which I commit to at this stage. I start by first providing descriptive and theoretical background information on both ergativity and Tlingit syntax. I then look specifically into absolutive “object” pronominal markers and their “high” position within Tlingit verbal morphology, arguing that they are best modeled as clitics whose positions are likely unrelated to absolutive case assignment. After this I discuss ergative “subject” pronominal markers and the tension between their structural and inherent case properties. With the current data, I propose that – depending on the assumptions one makes – subject pronominal markers can be analyzed as having either inherent case or structural case, or as reflecting agreement with two distinct functional heads. Finally, I examine the morphological and syntactic distribution of the nominal ergative suffix *-ch*, and argue that it is best analyzed as a postposition that reflects dependent case. Building off of an account whereby subject pronominal markers reflect agreement, I then propose a model that can account for the difference in alignment properties between nominals marked with *-ch* and subject pronominal markers.

Acknowledgements

In this thesis I look into the two issues that have fascinated me the most during my time at Yale: ergative case alignment and the Tlingit language. I owe my interest in these issues first and foremost to Jim Wood and James Crippen. I thank Jim for sparking my interest in both argument structure and morphology – two topics which form the cornerstones of any theory of ergativity. I also thank him for being an incredibly helpful, devoted and encouraging teacher and mentor to me for the past two years. I thank James for introducing me to the Tlingit language and the Na-Dene language family, for selflessly sharing his own groundbreaking work on Tlingit with me, and for always encouraging me to delve deeper into the topic. His own work on the Tlingit language, and the excellent data he has collected, always form the foundation of any work I do on Tlingit. I would be lucky to ever become as thorough and devoted to the study of language as either Jim or James.

A special thanks also goes to Raffaella Zanuttini, both for first introducing me to syntax and for being an excellent mentor throughout the process of writing the senior essay. The time spent with her in both LING 490 and 491 was invaluable in keeping me focused and accountable, and her encouragement was always very uplifting in difficult circumstances. Finally, I thank both of my parents for their unwavering love and support, and for always being enthusiastic about me pursuing my interest in linguistics.

I also congratulate all of my fellow seniors for their excellent work, and for persevering in this process in the midst of a global pandemic that has fundamentally changed the way we experience being students at a university.

Contents

1	Introduction	5
2	Ergativity: Description and Analysis	6
2.1	The Characteristics of Ergativity	6
2.2	Ergativity as a Heterogeneous Phenomenon	8
2.2.1	Ergative Splits	8
2.2.2	Morphological vs. Syntactic Ergativity	9
2.3	Ergativity in Syntactic Theory	10
2.3.1	Dependent Case Accounts	10
2.3.2	Functional Head Accounts	11
3	The Tlingit Language: Background and Grammar	14
3.1	The Tlingit Language	15
3.2	Tlingit Syntax	15
3.2.1	Configurationality	16
3.2.2	The Verbal Complex	17
3.2.3	The Status of Pronominal Markers	21
4	Ergativity in Tlingit: The Basic Properties	26
4.1	The Alignment Pattern of Pronominal Markers	26
4.2	The Alignment Pattern of Independent DPs	28
4.3	Tlingit is not Syntactically Ergative	30
5	Discerning the Case Properties of Absolutive Markers	31
5.1	The “High” Position of Absolutive Markers and Challenges to an Argument Analysis	31
5.1.1	An [EPP] Feature Overgenerates	32
5.1.2	Incorrect Predictions about Syntactic Ergativity	32
5.2	The Clitic Analysis and Default Case	33
5.2.1	The Initial Advantages of a Clitic Analysis	33
5.2.2	Alternative Loci of Absolutive	34
6	The Dual Nature of Ergative Markers	36
6.1	The Case Properties of Ergative Markers	36
6.1.1	Ergative Markers Disappear in Causatives	38
6.2	Towards a Tentative Analysis	39
6.2.1	Ergative is Inherent, Causees Receive a Different Case	39
6.2.2	Ergative Is Structural	41
6.2.3	Ergative is Assigned by Multiple Heads	43
7	The Ergative Suffix <i>-ch</i> and its Relation to Pronominal Markers	44
7.1	The Distribution of <i>-ch</i>	44
7.1.1	The Morphological Distribution of <i>-ch</i>	45
7.2	<i>-Ch</i> and the Adpositional Ergative Analysis	46
7.3	Modeling the Ergative Properties of <i>-ch</i>	47
7.3.1	<i>-ch</i> Reflects Dependent Case	47
7.3.2	Two Types of “Ergative” in Tlingit	48
8	Conclusion	51

List of Abbreviations

Abbreviations in Tlingit Glosses

1	1st Person
2	2nd Person
3	3rd Person
3ON3	3rd Person on 3rd Person Marker
ABS	Absolutive
CNJ	Conjugation Prefix
CSV	Causative
ERG	Ergative
FOC	Focus
FUT	Future
GCNJ	<i>g</i> - Conjugation
<u>G</u> CNJ	<i>g</i> - Conjugation
HSFC	Horizontal Surface Marker
IRR	Irrealis
MID	Middle
MOD	Modal
MSDT	Mesiodistal Marker
NCNJ	<i>n</i> - Conjugation
OBJ	Object
PFV	Perfective
PL	Plural
PROX	Proximal Marker
PSS	Possessive
REFL	Reflexive (Anaphor)
REL	Relative Clause Marker
S	Singular
STV	Stative
SUB	Subject
XTN	Extensional

Abbreviations Seen in Non-Tlingit Glosses

A	Agent
A	A Series Marker
AUX	Auxiliary
B	B Series Marker
DTV	Derived Transitive
INTRANS	Intransitive
ITV	Intransitive Verb Suffix
LAT	Lative
NONFUT	Nonfuture
OS	Oblique Stem
P	Patient
PAST	Past Tense
PERF	Perfective
PRF	Perfective
PRFV	Perfective
PTCP	Participle
SG	Singular
TRANS	Transitive
TV	Transitive Verb Suffix

1 Introduction

This thesis explores the syntax of case alignment in Tlingit, a Na-Dene language spoken in southeastern Alaska and the Yukon territory. On a broad level, Tlingit exhibits an ergative-absolutive alignment system, whereby transitive subjects are in most instances indexed with a different morphology than intransitive subjects and transitive objects (Crippen 2011, Crippen and Déchaine 2015). This is seen in both Tlingit’s nominal morphology and its system of verbal pronominal markers, often labeled “subject” and “object” markers (Crippen 2019).

(1) Ergativity in Nominal Morphology¹

- a. Transitive Subject (Cable 2018:53)

aɣ tláa -ch asiɣan aɣ éesh
 1S.PSS mother **-ERG** IMPF.love 1S.PSS father
 ‘My mother loves my father.’

- b. Transitive Object (Crippen 2019:267)

i tláa xasiɣán
 2S.PSS mother 1SSUB.IMPF.love
 ‘I love your mother.’

- c. Intransitive Subject (Cable 2018:52)

aɣ tláa al'eix
 1S.PSS mother IMPF.dance
 ‘Mother is dancing.’

(2) Ergativity in Pronominal Markers

- a. Transitive Subject (Crippen 2019:701)

*Yiw**t**usiteen*
 2PLOBJ.PFV.1PLSUB.see
 ‘We saw you.’

- b. Transitive Object (Crippen 2019:700)

***Haa** yisiteen*
 1PLOBJ= 2SSUB.PFVsee
 ‘You saw us.’

- c. Intransitive Subject (Crippen and Déchaine 2015:6)

***Haa** woonaa*
 1PLOBJ= PFV.die
 ‘We died.’

In (1), the ergative marker *-ch* appears solely on the transitive subject, whereas the object and intransitive objects have no suffixation. Likewise in (2) the subject marker *tu-* only indexes the the 1st person plural argument when it is the transitive subject, with the object marker *haa=* representing 1st person plural arguments elsewhere.

When the case alignment properties of both nominal elements and pronominal markers are examined in more detail than this, several interesting patterns emerge which warrant further syntactic analysis. The

¹For all Tlingit glosses I use the so-called “Revised Popular” (RP) orthography, also used in Crippen’s work (2011, 2012, 2013, 2019).

patterns associated with pronominal markers are of particular interest, as their implications and potential analyses can change depending on whether one analyzes pronominal markers as true verbal arguments that should be treated like DPs, or something more akin to clitic doubling. In this essay, I look into three particular phenomena related to ergative-absolutive case alignment in Tlingit, offering several potential syntactic analyses to account for them. I offer multiple analyses for the majority of these phenomena, as opposed to just one, because at this point I am still working with a limited set of data that is compatible with numerous syntactic models. Together, the topics I analyze present a broad overview of ergativity in Tlingit.

First, I examine the nature of absolutive case assignment on object pronominal markers, specifically looking into how to best model the relationship between absolutive case assignment and the “high” position of object markers within the Tlingit verb. I argue that this high position is best modeled as *not* being related to absolutive case, if object markers are analyzed as clitics. Second, I examine the properties of ergative subject markers, providing several analyses to account for the fact that they exhibit the properties of both inherent and structural ergative case. I show that subject markers can ultimately be analyzed as realizing inherent or structural case, depending on one’s assumptions, or that they can alternatively be modeled as reflecting agreement with two functional heads. Finally, I look into the distribution of the ergative nominal suffix *-ch*, specifically exploring the implications of the fact that nominals marked with *-ch* exhibit a slightly different alignment pattern than ergative subject markers. I provide one potential analysis, proposing that *-ch* is a postposition which realizes dependent case, and that pronominal markers have a different distributional pattern because they reflect agreement as opposed to case.

The essay is organized as follows. Section 2 provides a broad overview of the phenomenon of ergativity from both a descriptive and a theoretical standpoint. Section 3 establishes the necessary background on the Tlingit language and its syntax, before going into a specific discussion on the unclear syntactic nature of pronominal markers. Section 4 discusses the specific properties of ergative case alignment in Tlingit, examining the patterns associated with both pronominal markers and independent DPs. Sections 5 through 7 then discuss the specific issues related to ergative alignment outlined above. Section 5 looks into the absolutive case as expressed through object pronominal markers, Section 6 looks into the nature of ergative case on subject markers, and Section 7 looks into the properties and distribution of the ergative suffix *-ch*.

2 Ergativity: Description and Analysis

Before discussing any topics related to ergativity specifically within Tlingit, I will first provide a general overview of the phenomenon of ergativity from a descriptive and theoretical standpoint. Specifically, I highlight the basic cross-linguistic properties of ergative-absolutive alignment, before reviewing several prominent syntactic analyses of the pattern within a modern Minimalist framework.

2.1 The Characteristics of Ergativity

On the broadest level, a language is labeled as “ergative” or “ergative-absolutive” if transitive subjects receive a distinct morphological marking from intransitive subjects and transitive objects (Dixon 1979, 1994). Adopting Dixon’s (1979, 1994) terminology, the morphological marking associated with transitive subjects (A) is labelled “ergative,” in contrast to the “absolutive” morphology used for both intransitive subjects (S) and transitive objects (O). Thus, an ergative-absolutive language stands in contrast to a “nominative-accusative” language, in which transitive *objects* (O) receive a morphological marking distinct from transitive (A) and intransitive subjects (S).

(3) Ergative-Absolutive vs. Nominative-Accusative Alignment (figure from Friend 1985)

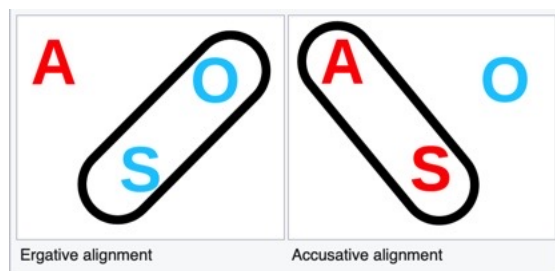

Often, the distinct morphology separating transitive subjects from intransitive subjects and transitive objects comes in the form of a case affix, as demonstrated by the following pattern from Dyirbal.

(4) Ergative Case Morphology in Dyirbal²

- a. *ɲuma banaga-n^ɲu* (Dixon 1994:10)
 father.ABS return-NONFUT
 ‘Father returned.’
- b. *ɲuma yabu-ɲgu bura-n* (Dixon 1994:10)
 father.ABS mother-ERG see-NONFUT
 ‘Mother saw father.’
- c. *yabu ɲuma-ɲgu bura-n* (Dixon 1994:10)
 mother.ABS father-ERG see-NONFUT
 ‘Father saw mother.’

In (4a) and (4b), *ɲuma* ‘father’ is the intransitive subject and the transitive object respectively, and in both instances it receives the same bare case-marking. This is contrasted with (4c), where the transitive subject *ɲuma* precedes the ergative case suffix *ɲgu*. Ergativity does not only have to be expressed through case, however. Often, it is indicated solely through morphological markers on the verb. Take the following examples from the Mayan language Chol.

(5) Ergative Verbal Morphology in Chol

- a. *Tyi ts’äm-i-yoñ* (Coon 2010:46)
 PRFV bathe-ITV-B1
 ‘I bathed.’
- b. *Tsa-bi y-il-ä-yoñ* (Coon 2010:46)
 PRFV-REP A3-see-DTV-B1
 ‘She reportedly saw me.’
- c. *Tyi k-wuts’-u pisil* (Coon 2010:46)
 PRFV A1-wash-TV clothes
 ‘I washed clothes.’

In (5c), the 1st person “A series” marker *k-* marks the 1st person transitive subject directly on the verb *wuts’* ‘wash,’ while in (5a) and (5b) the “B series” marker *-yoñ* marks the object and intransitive subject, in both cases also attaching to the verb root (Coon 2010).

²The glosses for the examples in this section generally follow the conventions of the authors they were taken from.

2.2 Ergativity as a Heterogeneous Phenomenon

While the defining characteristics of ergativity are relatively straightforward, a vast body of evidence suggests that it is not a uniform phenomenon across the world’s languages. Languages labeled as “ergative” differ widely in the consistency with which they use ergative-absolutive alignment, in addition to how similarly they behave to nominative-accusative languages when it comes to operations such as A’-movement.

2.2.1 Ergative Splits

In many of the world’s languages, ergative-absolutive alignment disappears under certain conditions, leading these languages to be characterized as “split ergative” (DeLancey 1981). One factor that can condition split ergativity is Aspect. In Basque, for example, ergative case-marking on transitive subjects is never realized in the presence of the progressive aspectual morpheme *ari*.

(6) Aspect Splits

- a. Ergative Case without *ari* (Laka 2006:173)

Emakume-a-k ogi-a jaten du
 woman-DET-**ERG** bread-DET eating has
 ‘The woman eats the bread.’

- b. No Ergative Case with *ari* (Laka 2006:173)

Emakume-a ogi-a jaten ari da
 woman-**DET.ABS** bread-DET eating **PROG** has
 ‘The woman is eating the bread.’

Another factor that commonly affects ergative marking is person and animacy. In several languages, such as Kham and Halkomelem Salish, 3rd person arguments trigger ergative case or agreement, whereas 1st and 2nd person arguments do not (Watters 1973, Wiltschko 2006). Take the following paradigm from Kham, where the 3rd person subject *no* is followed by the ergative suffix *-e*, in contrast to the 1st person *nga*:

(7) Person Splits

- a. Ergative on 3rd Person Subject (Waters 1973, via Coon and Preminger 2012:313)

No-e nən-lay poh-na-ke-o
 he-**ERG** you-OBJ hit-2P-PERF-3A
 ‘He hit you.’

- b. No Ergative on 1st Person Subject (Waters 1973, via Coon and Preminger 2012:313)

Nga: nən-lay nga-poh-ni-ke
I you-OBJ 1A-hit-2P-PERF
 ‘I hit you.’

Finally, other languages display what is known as “split-S” alignment, also called “split intransitivity” (Dixon 1994). Split-S is not necessarily a pattern whereby ergative marking disappears under certain contexts, but rather a distinct phenomenon in which ergative and absolutive marking are determined on the basis of semantic roles rather than transitivity. That is to say, arguments with agent roles are generally marked ergative, whereas patients are marked absolutive. This manifests itself in a split in the morphological indexing of the intransitive subject S (hence the name split-S). Unergative agent subjects align with transitive subjects in being marked ergative, whereas unaccusative patient subjects align with transitive objects being marked absolutive. Aldai (2009) argues that this is the case for the western dialects of Basque.

- (8) Split-S Alignment for Intransitives
- a. Unaccusative - Absolutive Subject (Aldai 2009:789)

Peru erori da
Peter.ABS fall is
 ‘Peter has fallen.’

- b. Unergative - Ergative Subject (Aldai 2009:790)

Peru-k dantzatu du
 Peter-**ERG** dance has
 ‘Peter has danced.’

2.2.2 Morphological vs. Syntactic Ergativity

The discussion above demonstrates that ergative languages form a heterogeneous class based on differences in how ergative-absolutive alignment can be conditioned. In addition to this, there is a deeper syntactic division between the world’s ergative languages, in that they exhibit different properties when it comes to operations such as A’-movement.³ This difference is often analyzed as a split between languages that are only morphologically ergative versus languages that are additionally *syntactically ergative* (Dixon 1972, 1979, Bittner and Hale 1996).

Morphological Ergativity

Languages that only exhibit morphological ergativity have some type of ergative-absolutive alignment system, but behave similarly to nominative-accusative languages in their properties related to phenomena such as A’-movement (Deal 2016). As in nominative-accusative languages, transitive subjects in purely morphologically ergative languages can freely undergo movement in A’-constructions such as relative clauses and wh-questions while also leaving a gap. Following the Noun Accessibility Hierarchy, this additionally means that direct objects can undergo A’-movement as well in several morphologically ergative languages (Keenan and Comrie 1977). The examples below of subject and object relativization from Tsez demonstrates this.

- (9) Subject and Object Relativization
- a. Object Relative Clause (Polinsky 2015:266)

[*Už-ä* _{abs} *kid-be-r* *tal-ru*] *kayat*
 [boy-ERG girl-OS-LAT give-PAST.PTCP] **letter.ABS.II**
 ‘the letter that the boy gave to the girl’

- b. Transitive Subject Relative Clause (Polinsky 2015:266)

[_{erg} *Kayat* *kid-be-r* *tal-ru*] *uži*
 [letter girl-OS-LAT give-PAST.PTCP] **boy.ABS.I**
 ‘the boy that gave a letter to the girl’

Assuming a standard view of relative clauses, the grammaticality of (9a) and (9b) demonstrates that the operators that index the object *kayat* ‘letter’ and the transitive subject *uži* ‘boy’ can both undergo movement to [spec, CP] in a relativization operation.⁴ This makes a morphologically ergative language like Tsez similar to a nominative-accusative language like English, as transitive subject and object relatives are grammatical in both languages.

³A subset of languages that exhibit different A’-movement properties also exhibit different properties related to control. For the purposes overview I will only discuss differences in A’-movement.

⁴Note that in (9b) what moves is the null ergative operator – this is why the overt form of *uži* is absolutive.

Syntactic Ergativity

A subset of morphologically ergative languages *do not* show the same A'-movement properties as nominative-accusative languages, and are thus often labelled “syntactically ergative.” Whereas transitive subjects and objects can freely undergo A'-movement in nominative-accusative languages, syntactically ergative languages exhibit *a ban on extracting transitive subjects* (Dixon 1979, Deal 2016). The following relative clauses from Inuit demonstrate.

(10) Relativization in Inuit

- a. Intransitive Subject Relative (Bittner 1994:55, via Deal 2016)

Miiqa-t [_{abs} *sila-mi* *pinnguar-tu-t*]
child-PL.ABS [_{abs} outdoors-LOC play-REL.INTRANS-PL]
 ‘the children who are playing outdoors’

- b. Transitive Object Relative (Bittner 1994:55, via Deal 2016)

Miiqa-t [*Juuna-p* _{abs} *paari-sa-i*]
child-PL.ABS [Juuna-ERG _{abs} look.after-REL.TRANS-3SG.PL]
 ‘the children that Juuna is looking after’

- c. *Transitive Subject Relative (Bittner 1994:55, via Deal 2016)

**Angut* [_{erg} *aallaat tigu-sima-sa-a*]
man.ABS [_{erg} gun.ABS take-PRF-REL.TRANS-3SG.SG]
 Intended: ‘the man who took the gun’

As shown (10a) and (10b), intransitive subjects and transitive objects can both be relativized. In (10c), however, relativization of a transitive subject with a gap is ungrammatical. As a repair strategy, Inuit has to use an antipassive marker to express a sentence with the meaning of (10c) (Bittner 1994). Note from (10b) that transitive subjects can remain in relative clauses in situ, with full ergative case-marking. Various proposals have been put forward to explain the difference in extraction properties between syntactically ergative and morphologically ergative languages, several of which will be expanded upon in the following section.

2.3 Ergativity in Syntactic Theory

The wide diversity of patterns that fall under the basic umbrella of “ergativity,” as outlined above, has understandably lead to a wide variety of syntactic accounts of the phenomenon. Many of these accounts focus explicitly on case-marking as opposed to verbal agreement, but their basic tenets can be extended to the domain of agreement. In this section I outline several of the leading accounts of how ergative-absolutive case assignment operates within the syntax.

2.3.1 Dependent Case Accounts

One of the most straightforward accounts of ergative-absolutive alignment is couched in the framework of *Dependent Case Theory* (Marantz 1991, Baker 2015). Dependent case claims that certain cases, specifically the ergative and the accusative, are reflections of c-command relationships between two DPs in the same domain. For ergative-absolutive languages in particular, ergative case is assigned *upwards* to a DP if it asymmetrically c-commands another DP within a relevant domain (Marantz 1991, Baker 2015, Baker and Bobaljik 2017) This is expressed by the following rule.

- (11) Dependent Ergative Assignment (Baker and Bobaljik 2017:112)
 If DP₁ c-commands DP₂ and both are contained in the same domain (say, clause), then value the case feature of DP₁ as ergative.

Accusative case, on the other hand, is assigned *downwards* to a DP if it is c-commanded by a structurally higher DP in the same domain. Therefore, the difference between ergative-absolutive and nominative-accusative languages can be reduced to a simple parameter, which is the direction of dependent case assignment (Marantz 1991, Baker and Bobaljik 2017).

(12) a. Upwards – Ergative Absolutive

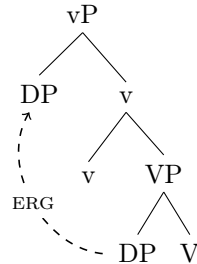

b. Downwards – Nominative Accusative

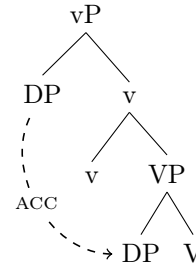

Within a dependent case framework, absolutive and nominative case represent *elsewhere* cases, which are assigned to a DP in the event that it does not receive lexical or dependent during the derivation. Both cases therefore show up on intransitive subjects in their respective languages. Because ergative dependent case is assigned upwards, absolutive case is also assigned to direct objects (Marantz 1991, Baker and Bobaljik 2017).

Dependent case theory is undoubtedly elegant in its simplicity, and in its powerful ability to reduce the difference between ergative and nominative languages to a single parameter. Problems arise, however, when phenomena such as split intransitivity are taken into account, as in these systems ergative case can surface in intransitive unergatives where no other DP is present, as demonstrated in (8b). One potential solution to this is to claim that unergatives actually have covert objects, and therefore that dependent ergative case assignment still occurs in these contexts (Marantz 1991).

2.3.2 Functional Head Accounts

Many alternative syntactic accounts of ergativity work within the assumption that both ergative and absolutive case are licensed by functional heads. These accounts therefore operate within the relatively standard assumptions that DPs are either assigned case through an agree relationship with a functional head, or that they reflect a θ -role associated with a certain head (Chomsky 2000, 2004, Woolford 2006). The accounts differ, however, in which heads they assume are responsible for assigning each case. For descriptive purposes, I will label the two accounts “High Absolutive, Low Ergative” and “High Ergative, Low Absolutive.”

High Ergative, Low Absolutive

When comparing ergative-absolutive languages to nominative-accusative languages, “high ergative, low absolutive” accounts of ergativity generally propose that the ergative is parallel to the nominative, and that the absolutive is parallel to the accusative (Rezac et al. 2014, Bobaljik 1993). Like the nominative, ergative case is licensed by a high inflectional head such as T. Like the accusative, absolutive case is licensed by a lower head such as an external argument-introducing little *v* (Rezac et al. 2014). This is demonstrated by the tree below.

(13) “High Ergative, Low Absolutive” Case Assignment

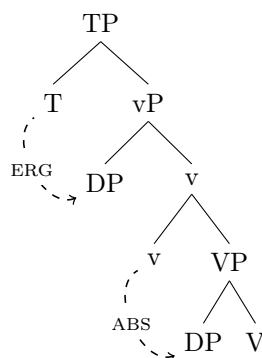

In a “high ergative, low absolutive” model, both the ergative and the absolutive are therefore taken to be *structural* cases, as opposed to *inherent cases* (Chomsky 1981, Woolford 2006). They are both assigned to a DP through an Agree relationship with functional head, and the assignment is independent of the theta role of the DP. Proponents of this framework often point to similar shared properties between the ergative and the nominative as evidence. Like the nominative in English, the ergative in Basque fails to appear in non-finite clauses related to verbs of perception, such as the following.

(14) No Ergative in Non-Finite Clauses (Rezac et al. 2014:1280)

Katu-ak *sagu-ak* *harrapa-tzen* *ikus* *ditut*
cat-ABS mouse-ABS catch-ing seen AUX
 ‘I saw the cats catch the mice.’

Nominative case is often analyzed as disappearing in non-finite clauses because they lack an inflectional head such as T that can assign nominative case. If the ergative case also disappears in non-finite clauses, it too must be licensed by a high inflectional head (Rezac et al. 2014). Moreover, the fact that the transitive causee *sagu-ak* ‘mouse’ shows up as absolutive lends credence to the claim that the absolutive – like the accusative – is assigned by little v, as the little v associated with the perception verb *ikus* ‘see’ in (14) is the nearest possible case-assigner.

If the ergative is essentially akin to the nominative, the question of why intransitive subjects surface as absolutive still remains. There are several ways to accommodate this in the “high ergative” framework. Bobaljik (1993) makes use of an *Obligatory Case Parameter*, which posits that in ergative languages absolutive structural case has to be obligatory realized in all representations. In more recent work, Rezac et al. (2014) claim that absolutive subjects are still case licensed by little v, but move to [spec, TP] to fulfill an [EPP] requirement, without being assigned case by T. This essentially requires two different types of T heads in Basque: one T_{ERG} that assigns ergative case, and an underspecified T that fails to (2014).

High Absolutive, Low Ergative

The “high absolutive, low ergative” family of analyses essentially proposes the reverse of the analyses discussed above. That is to say, the absolutive case is licensed by a high inflectional head, whereas the ergative case is licensed lower in the structure (Bok-Bennema 1991, Campana 1992, Murasugi 1992, Bittner 1994). In almost all of these analyses, the absolutive case is therefore equivalent to the nominative case.

Within this set of analyses, there is a substantial amount of variation in what is considered to be the lower locus of ergative case. Murasugi (1992), for example, takes the ergative case to be structural in nature, being assigned to a VP internal transitive subject that moves out of VP into the specifier of a “TransitivePhrase” (TrP). Ever since the verbal domain has been further articulated to include a little v or Voice head specifically dedicated to introducing external arguments (Chomsky 1995, Kratzer 1996), an influential proposal has been that the ergative is an *inherent* case. (Woolford 1997, 2006). That is to say,

ergative case marking is specifically associated with an external argument θ -role, and is thus licensed by the little v head that introduces external arguments to the derivation (Woolford 1997, 2006). The inherent case theory of ergativity works well within the high absolutive framework, as it guarantees that the ergative is licensed much lower than the absolutive. One potential drawback, however, is the common failure for ergative case to arise intransitives such as unergatives, even though the single argument is associated with an external argument θ -role. For this reason, several analyses propose a “transitivity condition,” whereby ergative case is only assigned by a transitive little v (Woolford 2006, Legate 2012).⁵ Considering an inherent view of ergative case, the following tree represents one representative version of the “high absolutive, low ergative” framework.

(15) “High Absolutive, Low Ergative” Case Assignment

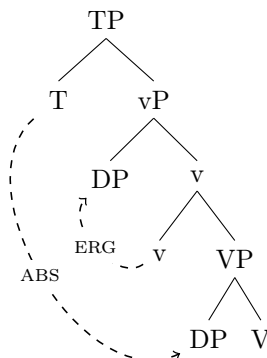

Treating the absolutive case as the nominative can often provide a neat account of the A'-extraction constraints seen in syntactically ergative languages, as discussed above. If little v P is treated as a phase, it follows that objects must move past the subject to the edge of this phase to receive absolutive case from a higher head, as they still need to remain active within the derivation. This movement past the subject has the potential to “trap” the subject within v P, thus rendering it unable to move (Coon et al. 2014). Coon et al. (2014) propose an analysis for several syntactically ergative Mayan languages along these lines, claiming that transitive subjects cannot undergo A' extraction precisely because the movement of objects traps them within v P (Coon et al. 2014).⁶

Heterogeneous Syntactic Analyses

As the diverse nature of ergative languages has been further expanded upon, several recent analyses have proposed that distinct types of ergative alignment exist in the syntax (Legate 2006, 2008, Aldridge 2004, 2008). One influential proposal is that of Legate (2008), which posits that ergative languages are broadly divisible into two types, in which the “absolutive” case encompasses radically different phenomena (2006, 2008). These distinct types are labelled ABS=DEF and ABS=NOM.

In both types of languages, the ergative is an inherent case assigned by little v . In, ABS=NOM languages, the absolutive case transparently corresponds to the nominative. In ABS=DEF languages, on the other hand, “absolutive” case is not a syntactic primitive, but rather a reflection of *default morphology* given to nominative and accusative DPs in languages that lack specific morphology for either case (Legate 2006, 2008). Intransitive subjects receive structural nominative case from an inflectional head such as T, whereas transitive objects receive accusative case from little v . Although the case-licensors for intransitive subjects and objects are different, they appear with the same default morphology on the surface. This proposal

⁵Another line of work circumvents the transitivity condition by claiming transitive and unergative subjects are merged in *different* positions, as opposed to the same little v head. In general, unergative subjects are merged lower in the derivation, in a position where they cannot receive ergative case (see Massam (2009) for Niuean and Tolan (2018) for Samoan.)

⁶It should be mentioned that Coon et al. (2014) do *not* assume that absolutive is akin to nominative across all languages. They assume it for some Mayan languages, providing an example of its empirical advantages.

makes use of a strong distinction between the notion of “abstract” case, which is assigned in the course of the syntactic derivation, and “morphological” case, which merely refers surface morphology (Legate 2006, 2008).

Coon et al. (2014) productive use the difference between ABS=NOM and ABS=DEF languages to derive the variation between morphologically ergative and syntactically ergative languages in the Mayan family. As mentioned in the previous section, Mayan languages that show syntactic ergativity are ABS=NOM, as the absolutive object moves past the subject for case-licensing purposes, trapping it within vP (Coon et al. 2014). Mayan languages that are ABS=DEF do not exhibit syntactic ergativity however, as in these cases the object is assigned case by little v, and thus has no need to move past the subject (Coon et al. 2014).

Another influential proposal about the heterogeneity of ergative syntax comes from the work of Aldridge (2004, 2008). To derive the difference between morphologically and syntactically ergative languages, Aldridge (2004, 2008) proposes a parameter whereby transitive little vP has an [EPP] feature in syntactically ergative languages, but not in morphologically ergative languages. In syntactically ergative languages, this [EPP] feature attracts the object to a position above the subject, rendering the subject unable to move for A'-purposes. Subjects can freely move in morphologically ergative languages, however, because there is no [EPP] feature on little v that attract objects to a position above them (Aldridge 2004, 2008). The following trees demonstrate the difference between pure morphological ergativity and syntactic ergativity in Aldridge (2004, 2008)'s model.

(16) Aldridge (2004, 2008)

a. No Syntactic Ergativity

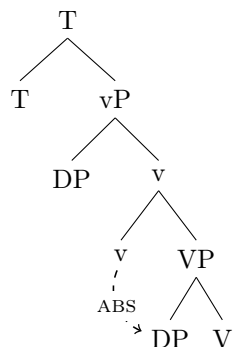

b. Syntactic Ergativity

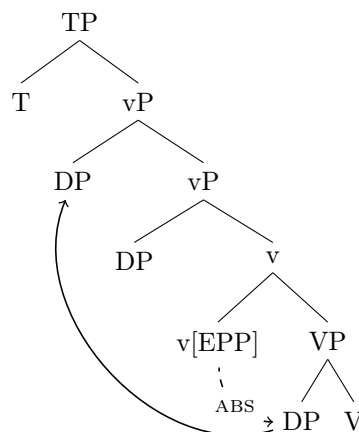

This concludes the overview of ergativity, and ergative-absolutive alignment, from both a descriptive and theoretical standpoint. As can be seen, it is undoubtedly a heterogeneous phenomenon that likely demands multiple distinct syntactic analyses. With the basic information about ergativity established, I now turn towards providing relevant information on the Tlingit language before explicitly discussing the properties of ergativity within Tlingit.

3 The Tlingit Language: Background and Grammar

In this section I provide a broad overview of the Tlingit language, with a specific focus on Tlingit syntax from both a descriptive and a theoretical standpoint. I begin with a brief summary of Tlingit's historical relationships and current social circumstances, before moving onto a discussion of several relevant properties of Tlingit syntax. I devote a particularly large amount of space to discussing the syntax of Tlingit's extensive verbal morphology, and conclude with a discussion of the theoretical status of Tlingit's system of verbal pronominal markers.

3.1 The Tlingit Language

Tlingit is a Na-Dene language spoken in small communities throughout southeastern Alaska and the Yukon Territory. It is generally considered critically endangered, with an estimated 100 to 200 native speakers remaining, although current efforts to revitalize the language are under way (Crippen 2019). Depending on the analysis, there are at least three discernible dialects with different phonological properties. These include the Northern dialect spoken in the Yukon territory and the Alaskan communities of Hoonah and Yakutat, the Southern dialect spoken around Wrangell and Ketchikan, and the distinctive Tongass dialect (Cable 2007, Crippen 2019). The majority of the data in this work comes from Crippen (2019), and thus largely represents the Northern dialect.

As a member of the Na-Dene language family, Tlingit is related to Eyak and the Athabaskan languages (Hamp and Chiarello 1979, Leer 1989, 2008). It forms the first branch of the Na-Dene family tree, being the sister language of the hypothetical Proto-Eyak-Dene language, which later diverged into the Eyak language and the Dene (Athabaskan) subfamily (Krauss 1964, 1965, 1973). These relations are schematized below.

(17) The Na-Dene Language Family

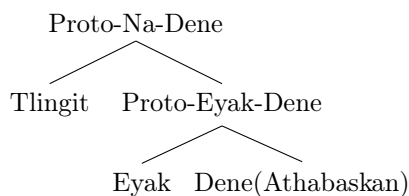

3.2 Tlingit Syntax

On a broad level, Tlingit grammar is characterized by its extensive verbal morphology and relatively free word order (Cable 2008, Crippen 2019). Most Tlingit verb forms contain the root in addition to a wide variety of prefixing morphological markers that encode information about stativity, transitivity and aspect. In addition to this, the “subject” and “object” pronominal markers mentioned in the introduction also occur as prefixes on the verb (Crippen 2019). The following example demonstrates.⁷

(18) Tlingit Verbal Morphology (Crippen 2019:246)

Iwtulichún
i- wu- tu- l- i- chun
 2SOBJ- PFV- 1PLSUB- CSV- STV- wound
 ‘We wounded you.’

In the form above, the root *chun* ‘wound’ is preceded by morphemes indicating causativization and perfective aspect, as well as two pronominal markers that index the subject and the object arguments. This system of prefixation results in the fact that a single phonological word in Tlingit can often express the meaning of an entire sentence in English (Crippen 2019). Looking beyond verbs, Tlingit exhibits a relatively free word order, with almost any order of subject, object and verb possible (Cable 2008).

(19) Word Order Possibilities in Tlingit

a. SOV (Cable 2008:3)

Wé shawaatch xóots awsiteen
Wé shawaat -ch xóots a- w- s- i- teen
 That woman -ERG bear 3ON3- PFV- XTN- STV- see
 ‘That woman saw the bear.’

⁷My glosses for Tlingit verbal morphology broadly reflect Crippen’s (2019) syntactic analysis of verbs in Tlingit, further discussed in the following section.

- b. SVO (Cable 2008:3)
 Wé shawaatch wusiteen xóots
Wé shawaat -ch wu- s- i- teen xóots
 That woman -ERG PFV- XTN- STV- see bear
 ‘That woman saw the bear.’
- c. OVS (Cable 2008:3)
 Xóots awsiteen wé shawaatch
Xóots a- w- s- i- teen wé shawaat -ch
 Bear 3ON3- PFV- XTN- STV- see that woman -ERG
 ‘That woman saw the bear.’
- d. OSV (Cable 2008:3)
 Xóots wé shawaatch wusiteen
Xóots wé shawaat -ch wu- s- i- teen
 Bear that woman -ERG PFV- XTN- STV- see
 ‘That woman saw the bear.’
- e. VSO (Cable 2008:3)
 Awsiteen wé shawaatch xóots
A- w- s- i- teen wé shawaat -ch xóots
 3ON3- PFV- XTN- STV- see that woman -ERG bear
 ‘That woman saw the bear.’
- f. VOS (Cable 2008:3)
 Awsiteen xóots wé shawaatch
A- w- s- i- teen xóots wé shawaat -ch
 3ON3- PFV- XTN- STV- see bear that woman -ERG
 ‘That woman saw the bear.’

3.2.1 Configurationality

Given the freedom of word order, in addition to the fact that Tlingit uses verbal pronominal markers to encode argument structure relations as in (18), one might come to the initial conclusion that Tlingit is a non-configurational head-marking language (Jelinek 1984, Nichols 1986). That is to say, all argument structure relations are expressed through pronominal clitics on verbs,⁸ with nominal elements constituting adjuncts added later in the derivation. There is ample evidence that shows, however, that this is not the case.

For one thing, Tlingit clearly displays some of the properties of a dependent-marking language, as information about grammatical relations can be expressed on nominals as well as verbs (Nichols 1986). In all of the sentences in (19), for example, *wé shawáat* ‘that woman’ is indexed as a transitive subject by being marked with the ergative suffix *-ch*.

Beyond this, Cable (2008) provides evidence that Tlingit is indeed a configurational language through a variety of other diagnostics. For example, Tlingit exhibits the classic “Principle C effects,” whereby pronouns within an object DP can be co-referential with an R-expression subject, but R-expressions within an object DP *cannot* be co-referential with a pronoun subject (Cable 2008).

⁸Working on Warlpiri, Jelinek (1984) actually proposes that the clitics appear on AUX, but the general principle is the same.

(20) Principle C Effects

- a. R-Expression Subject, Possessive Pronoun

(Cable 2008:5)

Bill du tlaa asixán

*Bill*₁ [*du*₁ *tlaa*] a- s- i- xán
Bill₁ [*his*₁ *mother*] 3ON3- CSV- STV- love
'Bill₁ loves his₁ mother.'

- b. *Pronoun Subject, Possessive R-Expression

(Cable 2008:5)

*Ø Bill tlaa asixán

Ø₁ [*Bill*₁ *tlaa*] a- s- i- xán
*pro*₁ [*Bill*₁ *mother*] 3ON3- CSV- STV- love
'He₁ loves Bill's₁ mother.'

In order for Principle C effects to arise, subjects and objects have to exist in a configuration whereby subjects asymmetrically c-command objects. R-expressions within an object DP cannot be co-referential with a c-commanding subject pronoun because they would then be bound, violating Principle C. These diagnostics, along with several others concerning wh-superiority effects, clearly demonstrate that Tlingit is configurational in the sense that subjects clearly asymmetrically c-command objects (Cable 2008). A model in which nominals are adjuncts would fail to predict consistent Principle C effects based on subject-object asymmetries.

3.2.2 The Verbal Complex

As mentioned earlier, a defining feature of Tlingit is its vast system of prefixing morphology that can be attached to the verb root. The Tlingit “verbal complex” – a term I will use to describe a verb root and the affixes surrounding it – can contain morphological markers that encode information about a wide variety of phenomena, including stativity, transitivity, aspect, spatial dynamics, and the realis/irrealis distinction. These morphemes all occur alongside the subject and object markers that index verbal arguments (Crippen 2019). This system results in the fact that sentence equivalents in English can be expressed through a single phonological word in Tlingit. The following sentence provides a good demonstration.

(21) Tlingit Verbal Complex

(Crippen 2019:701)

Yiwtusiteen

yi- *wu-* *tu-* *s-* *i-* *teen*
2PLOBJ- PFV- 1PLSUB- XTN- STV- see
'We saw you.'

In (21), the verb root *teen* ‘see’ is immediately preceded by the stative marker *i-*: a morpheme that indicates lexical stativity or result states in combination with the perfective aspect. Following *i-* is *s-*: an “extensional” morpheme indicating that the eventuality denoted by the verbal complex is extended through space. Added to this are the 1st person plural subject pronominal marker *tu-*, the perfective aspect marker *wu-*, and finally the 2nd person plural object pronominal marker *yi-*. In combination with the root, these prefixes productively express the meaning ‘We saw you.’

Looking beyond the basic structure of this verb form, several specific features are worth noting. First, observe that there is no morpheme which is glossed as Tense. Crippen (2019) notes that, whereas Tlingit has a wide variety of morphological markers associated with some type of Aspect, there is relatively little Tense morphology. Beyond this, note that the object marker *yi-* occurs much further from the root than the subject marker *tu-* – a pervasive pattern throughout the Tlingit paradigm when both markers are present.⁹

⁹Note that this isn't necessarily the case in 3rd person on 3rd person configurations, where the morpheme *a-* is solely responsible for indicating two 3rd person arguments (Crippen 2019).

Although it is not well-demonstrated by example (21) above, another feature of the Tlingit verbal complex worth mentioning is its intricate system of conjugation class prefixes and aspectual morphology. Verb roots are lexically specified for one of four conjugation class prefixes: (\emptyset , *g-*, *g-* or *n-*), which only show up overtly in certain forms near the left edge of the verbal complex. Whereas no overt conjugation class markers are ever seen in perfectives with *wu-*, for example, they consistently surface in imperatives. (Crippen 2019).

- (22) a. *n-* Conjugation Imperative (Crippen 2019:495)
 Nagoon!
n- *hoon*
 NCNJ- sell
 ‘Sell it!’
- b. *g-* Conjugation Imperative (Crippen 2019:495)
 Gaxoox
g- *xux*
 GCNJ- summon
 ‘Summon him/her!’

In the forms above, the conjugation prefix that appears is lexically specified by the conjugation class of the verb root. Interestingly, however, conjugation prefixes can also have more productive roles in indicating certain aspects. The *g-* conjugation prefix, for example, is used in combination with the irrealis marker *u-* and the “modal” marker *g-* to form the prospective aspect, as seen below (Crippen 2019).

- (23) Prospective Aspect (Crippen 2019:500)
 Ikkwasa.ée
i- *w-* *g-* *g-* *x-* *s-* *i*
 2SOBJ- IRR- GCNJ- MOD- 1SSUB- CSV- cook
 ‘I will cook you.’

The sentence above also demonstrates how morphologically complex the expression of Aspect can be in Tlingit. Whereas perfective aspect is indicated solely through the perfective marker *wu-*, the prospective aspect is formed through three distinct morphemes. With the basic features of Tlingit verbal complex laid out from a descriptive standpoint, I now turn towards describing some of the various analytical approaches used to model it.

Templatic Analyses

Given its complexity and somewhat rigid order, until relatively recently the verbal complex has been analyzed as a template, with specific slot for every class of morpheme that can prefix to the verb root (Leer 1991, Eggleston 2013). In his handbook on Tlingit Verbal Structure, James Crippen (2013) provides perhaps the most extensive template today, seen here compared alongside that of Leer (1991).

(24) The Tlingit Verbal Template (Crippen 2013 vs Leer 1991)

<i>Cable & Crippen</i>		<i>Leer 1991</i>	
+18	bound phrases	—	—
+17	preverbs (A–D, E1, E2, F)	+8	proclitic adjunct phrases
+16	reciprocal & outer distributive	+7	b number prefixes
+15	plural number <i>has=</i> ~ <i>s-</i>		a
+14	objects	+6	b incorp. obj. pronominals
+13	areal <i>ku-</i>	—	—
+12	alienable incorporates		a incorp. alienable nouns
+11	inalienable incorporates	+5	c incorp. inalienable nouns
+10	vertical surface <i>ya-</i>		b
+9	horizontal surface <i>ka-</i>		a
+8	self-benefactive <i>ga-</i>	+4	e schetic prefixes
+7	outer conjugation		d
+6	irrealis		c
+5	inner conjugation		b
+4	perfective and <i>ga</i> -modal		a
+3	inner distributive	+3	distributive prefix
+2	subjects	+2	subject pronominals
+1	classifiers	+1	classifier
0	root	0	ROOT
-1	stem variation	-3	inner mode suffixes
-2	derivation	-1	derivational suffixes
-3	duration (A?, B?)	-2	durative suffixes (a, b)
-4	mode	-4	outer mode suffixes
-5	epimode		epimode and
-6	clause type	-5	clause type suffixes
-7	bound auxiliaries	—	—

Within the templatic framework, Tlingit verbal complexes are analyzed minimally as having a root, a “classifier” prefix and either a subject marker or an object marker depending on the valence properties of the root. The classifier always comes from a set of 16 prefixes, each of which are built up from one of four “basic” prefixes – (*s-*, *l-*, *sh-* or \emptyset) – which in turn occur with or without the more abstract “D-” and “I-” elements. In a templatic analysis of the form in (21), for example, the sequence *si-*, made up of the extensional marker *s-* and the stative marker *i-*, would be considered the classifier. The table below demonstrates all possible classifiers within a templatic analysis.

(25) Tlingit Classifier System (adapted from Eggleston 2013)

	s-		l-		sh-		\emptyset	
	+I	-I	+I	-I	+I	-I	+I	-I
-D	si-	sa-	li-	la-	shi-	sha-	ya-	\emptyset -
+D	dzi-	s-	dli-	l-	ji-	sh-	di-	d-

Minimalist Analyses

While the template provides an excellent descriptive framework for the Tlingit verbal complex, several more modern analyses have modeled the Tlingit verb as being regularly built up in the syntax through the standard operations of Merge and Move. Foremost among these is Crippen (2019)’s analysis, which essentially proposes that the Tlingit verbal complex encodes the syntax of an entire clause. In particular, the verbal complex realizes a syntactic structure that starts at the verb phrase (VP) and projects maximally up to an Aspect phrase. Within this structure, subject and object pronominal markers are not agreement, but instead true arguments of the verb, represented as DP-like instantiations of the category D.

One of the foundational concepts of this analysis is that the classifier prefixes actually consist of one to three distinct syntactic heads. The I- element is the head of an Eventuality phrase which indicates stativity. The basic prefixes (*s-*, *l-*, *sh-* or \emptyset) are covert and overt values of a little *v* head, which introduces external arguments in its specifier. *S-* and *l-* in particular impart a causative meaning, often adding external arguments to unaccusative constructions, or qualify the eventuality denoted by a verb by extending it in space.¹⁰ Finally, the D- element is the head of a “Voice” phrase responsible for argument suppression in passive and antipassive contexts and middle voice in reflexive contexts.¹¹ These three heads can occur largely independently of one another, but they can also occur in numerous combinations that give rise to the classifiers seen above.

Another important feature of Crippen (2019)’s analysis is his treatment of Aspect. Because aspectual information in Tlingit can be expressed through a variety of morphemes in combination with one another, as seen with the prospective aspect in (23), Crippen (2019) models the Aspect head (Asp) as a subtree of morphemes which can contain nodes for conjugation class, modal, and irrealis morphology. Minimally, Asp contains a covert imperfective (IPFV) node or a perfective (PFV) node expressed through *wu-*. Imperfective nodes can optionally occur with the conjugation node (CNJ), whereas perfective nodes must occur with a covert conjugation node.¹² In addition to this, irrealis (IRR) and modality (MOD) nodes can be merged as well to give rise to more complex aspects such as the prospective. The structure below demonstrates Crippen’s (2019) model of Aspect.

(26) Asp⁰ Subtree (Crippen 2019)

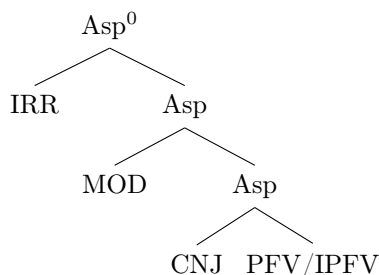

With the main details of Crippen (2019)’s framework established, we can now give representative examples of his syntax for the Tlingit verbal complex through the following trees. (27a) simply presents the hierarchical order of syntactic heads when all three “classifier” elements are present. (27b) applies the structure to an actual verb complex: the transitive *yiwtusiteen* ‘We see you’ seen in (21). For both examples I assume that Aspect is a subtree of morphemes, but I leave the details of this subtree out.

¹⁰On a broad scale *s-* and *l-* have an “argument-adding” function – for example adding instruments to transitive constructions (Crippen 2019). They could really be instantiations of multiple distinct heads, but I do not address the issue here.

¹¹I put “Voice” in quotes here only to indicate that it is distinct from the more common use of Voice as a head that introduces external arguments.

¹²An obligatory CNJ node may seem counterintuitive given that overt conjugation prefixes do not occur with *wu-* perfectives. Crippen (2019) claims it is obligatory, and covert, on the basis of idiosyncratic root behaviors conditioned only by conjugation class.

(27) a. Maximal Hierarchical Structure of Verbal Complex

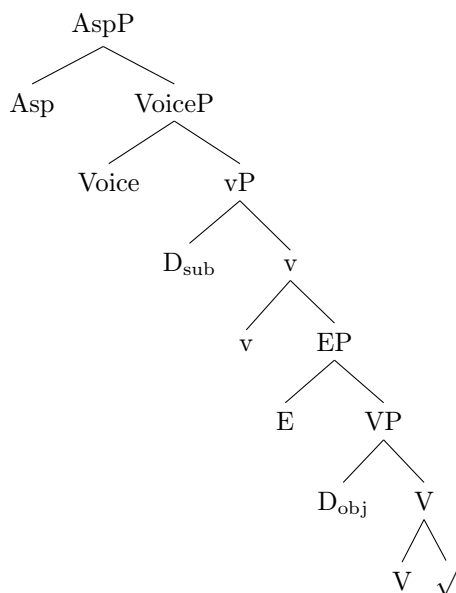

b. Yiwtusiteen

yi- wu- tu- s- i- teen
 2PLOBJ- PFV- 1PLSUB- XTN- STV- see
 ‘We saw you.’

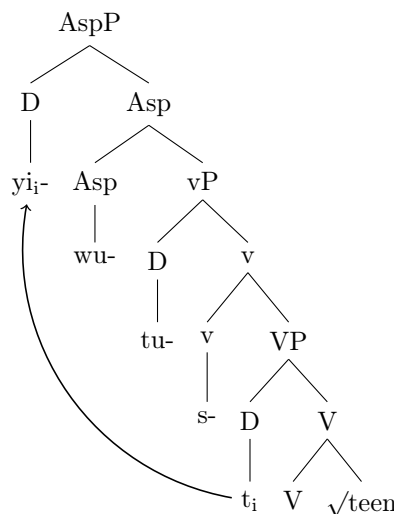

Looking at (27b), we can see that in Crippen (2019)’s framework the derivation of *yiwtusiteen* ‘We see you’ proceeds as follows. V verbalizes the root $\sqrt{\text{teen}}$ ‘see’ and introduces an internal argument in its specifier. The internal argument itself is the object pronominal marker *yi-*. The extensional little *v s-* merges with VP and adds an external argument in its specifier, in this case the 1st person singular subject marker *tu-*. A perfective Aspect head expounded by *wu-* then merges with vP.

Perhaps the most interesting part of Crippen (2019)’s analysis, somewhat necessitated by the linear ordering of morphemes, is that the object marker, while first merged as the internal argument in [spec, VP], moves to a much higher position in the specifier of Aspect. Crippen (2019) is relatively neutral as to why it moves, saying it could be either for phonological or case-related reasons.

Overall, Crippen (2019)’s model of Tlingit provides the best comprehensive syntactic account of its verbal structure so far, and I will assume several of its key features in my analysis going forward. In broad terms, I will assume that the morphemes associated with aspect, transitivity and stativity constitute syntactic heads. In particular, the classifier is really broken up into Voice, *v*, and E, which houses the stative marker *i-*. I will also assume that Aspect is a subtree of morphemes that minimally houses a null imperfective, but can also store the perfective marker *wu-* in combination with a covert conjugation prefix. Because Tlingit exhibits a strong disparity between tense and aspectual morphology, as mentioned earlier, I will also assume for the purposes of this essay that Aspect is the high inflectional head in Tlingit, which is potentially responsible for structural case assignment. This is not a novel assumption – see Coon et al. (2014) for a similar analysis of Mayan languages.

3.2.3 The Status of Pronominal Markers

While I adopt the majority of Crippen’s (2019) syntactic analysis of the Tlingit verbal complex, one feature that I will not fully commit to is the claim that pronominal markers are true arguments of the verb. While this analysis works well in some cases to explain the distribution of pronominal markers within the verbal complex, it has several drawbacks from a broader theoretical standpoint. In this section, I highlight the main issues that result from analyzing pronominal markers as arguments, and discuss the potential for alternatively analyzing pronominal markers as instances of agreement or clitic doubling. Without further data, I do not make a full commitment to any analysis.

The System of Pronominal Markers

As mentioned several times previously, Tlingit makes use of the two basic sets of pronominal markers. The set labeled “subject” markers consistently indexes transitive subjects, and the set labeled “object” markers consistently index transitive objects and most intransitive subjects (Crippen 2019).

(28) Subject and Object Markers

a. Subject Markers

Person and Number	Subject Marker
1st Sg	<u>x</u> a-
2nd Sg	i-
3rd Sg	∅
1st Pl	tu-
2nd Pl	yi-
3rd Pl	has ... ∅

b. Object Markers

Person and Number	Object Marker
1st Sg	<u>x</u> at=
2nd Sg	i-
3rd Sg	∅
1st Pl	haa-
2nd Pl	yi-
3rd Pl	has ... ∅
Reflexive	sh-
Reciprocal	woosh-

1st and 2nd person pronominal markers always have overt forms within the verbal complex. 3rd person singular subjects and objects have no overt pronominal marker, however. For these cases, I follow Crippen (2019) in assuming that 3rd person singular arguments are expressed through a null *pro* element (Crippen 2019). Both 3rd person plural subject and objects are expressed through the clitic *has=*, which occurs before Aspect. As discussed earlier, object markers occur further from the root than subject markers.

Crippen (2019): Pronominal Markers as D

Crippen (2019) models pronominal markers as determiner-like entities of the bare category D, largely as a means of proposing that bound pronominal markers have similar properties to independent DPs that occur outside of the verbal complex, but slightly less syntactic structure. A crucial aspect of this analysis is therefore that pronominal markers are not instances of agreement, but instead instantiate the true arguments of a clause. There is strong evidence for this proposal from the behavior of object markers, as they cannot appear with a co-referential independent DP unless that DP is separated through a topic or focus construction.

(29) Object Markers and Independent Pronouns

a. Object Marker without Independent Pronoun

(Crippen 2019:700)

Haa yisiteen

Haa= wu- i- s- i- tin

1PLOBJ= PFV- 2SSUB- XTN- STV- see

‘You saw us.’

b. *Object Marker with Independent Pronoun

(Crippen 2019:700)

*Uháan haa yisiteen

Uháan haa= wu- i- s- i- tin

1PL 1PLOBJ= PFV- 2SSUB- XTN- STV- see

Intended: ‘You saw us.’

- c. Object Marker with Independent Pronoun Separated by Focus (Crippen 2019:700)

Uháan áyá yisiteen

Uháan á -yá haa= wu- i- s- i- tin
 1PL FOC -PROX 1PLOBJ= PFV- 2SSUB- XTN- STV- see
 ‘It’s us that you saw.’

Crippen (2019) takes the ungrammaticality of sentences such as (29b) as evidence of the fact that pronominal markers themselves saturate the argument variables of verbs, and are therefore merged as arguments, as opposed to being morphological reflections of agreement. Independent pronouns therefore cannot co-occur with pronominal markers, unless there is a good degree of separation between the two, as in a focus construction such as (29c). This set of assumptions works quite well to model the data above, but it introduces several non-trivial theoretical issues.

Theoretical Implications of a D Analysis

Because pronominal D elements are analyzed as true arguments, there is a strong functional equivalence between pronominal markers and independent DPs in Crippen’s (2019) model. That is to say, Crippen (2019) proposes that both pronominal markers and independent nominals constitute arguments, and are thus merged in the same positions in the derivation. In particular, both subject pronominal markers and subject DPs are merged in the specifier of little *v*, with object pronominal markers and object DPs merged within VP. This set of assumptions has interesting consequences in a framework where the verbal complex has the syntax of an entire clause, as it fails to completely account for the distribution of independent DPs.

Looking at a sentence with only pronominal markers and no independent DPs, such as the one seen in (21) and (27b), Crippen’s (2019) assumptions work relatively well to explain the distribution of pronominal markers within the verbal complex.

- (30) Pronominal Markers (Crippen 2019:701)

Yiwtusiteen

yi- wu- tu- s- i- teen
 2PLOBJ- PFV- 1PLSUB- XTN- STV- see
 ‘We saw you.’

The subject marker *tu-* ‘we’ appears to the left of the little *v* head *s-*, something which is completely compatible with the claim that subject markers are true external arguments being merged in the specifier of little *v*. The object marker appears to the left of the Aspect head, but this could potentially be explained through some sort of [EPP] effect.¹³ When a sentence with independent nominals is considered, however, matters become much less clear.

- (31) Independent DPs (Cable 2008:3)

Wé shawaatch xóots awsiteen

Wé shawaat -ch xóots a- w- s- i- teen
 That woman -ERG bear 3ON3- PFV- XTN- STV- see
 ‘That woman saw the bear.’

If the verbal complex is treated as an entire clause, and independent DPs are taken to be merged in the same position as pronominal markers, the sentence above is only possible if both DPs have moved well outside of this clause to positions beyond Aspect. Crippen (2019) acknowledges this, claiming that independent nominals have to move past Aspect to a position beyond the verbal complex for phonological reasons, as they are too large to fit within it. While I do not rule this possibility out, it is clear that treating both

¹³This isn’t as clear cut as it seems when case-alignment is taken more seriously into account. I will return to this subject in Section 5.

independent DPs and bound pronominal markers as full arguments merged in the same position leaves a lot to be said about the distribution of DPs in Tlingit. In particular, for any sentence involving an independent DP, one has to stipulate that that DP has moved to some as of yet unspecified position. Moreover, proposing that DPs move outside of the verbal complex because they cannot fit within it requires a model in which the syntax has access to phonological processes, which is by no means a non-trivial assumption. As of now, the amount of access syntax has to phonology is still a hotly-contested issue (Anttila 2016), with several analyses claiming that syntax is truly “phonology-free” (Zwicky and Pullum 1986, Miller et al. 1997).

Given the discussion in Section 3.2.1, it is also very important to note that the position of independent DPs cannot simply be reduced to the fact that they are adjuncts merged above the true clausal architecture in the verbal complex. As Cable (2008) demonstrates, independent DPs in Tlingit exhibit a configurational structure with respect to one another, as there is strong evidence for subjects asymmetrically c-commanding objects. This fits well with the claim that independent subject and object DPs are merged in argument positions within a clausal syntax, and therefore that any model of their position has to assume that they are true arguments going forward.

A Potential Alternative

Given some of the disadvantages associated with analyzing pronominal markers as true arguments, it is important to discuss any potential alternative models. In this section I offer one such model, but acknowledge that it ultimately bears the burden of further proof, with no immediate evidence to back it up. In particular, the alternative I suggest is to analyze the “verbal complex” as a reflection of a complex M-word derived by head movement, as opposed to a full clause. Within this M-word, pronominal markers are not true arguments, but constitute either agreement morphology or doubled clitics. Abstracting away from several specific details, this model can be quite readily applied to a sentence like (31) with two independent nominals.¹⁴

(32) *Wé shawaatch xóots awsiteen* (Cable 2008:3)

Wé shawaat -ch xóots a- w- s- i- teen
 That woman -ERG bear 3ON3- PFV- XTN- STV- see
 ‘That woman saw the bear.’

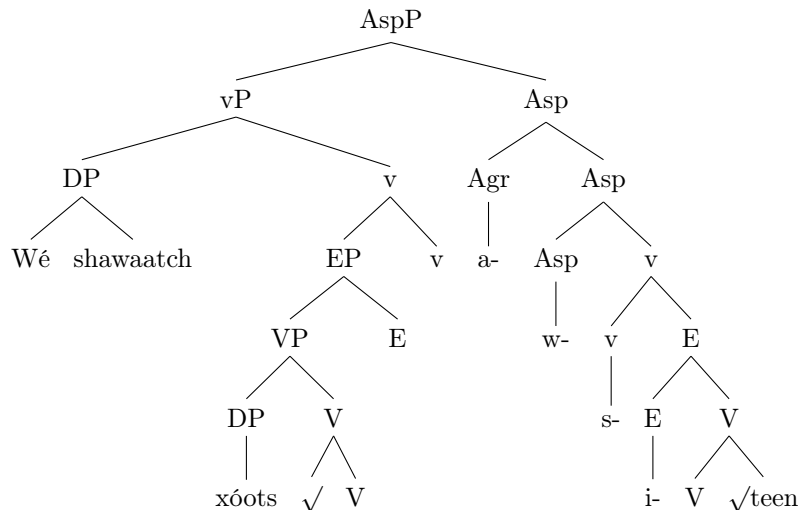

For sentences with independent DP arguments and no pronominal markers, a head movement analysis of the verbal complex offers an advantage in that it can derive the word order of a sentence such as (31) without requiring the DPs to move out of the clause. Moreover, it allows both the subject DP and the object DP

¹⁴I specifically abstract away from how the “3rd Person on 3rd Person” Agreement Marker *a-* is introduced. Note however that this “3 on 3” marker is also taken to be an instance of agreement by Crippen (2019), as opposed to an argument.

to be merged in true argument positions and therefore transparently exhibit the asymmetrical c-command relationship that gives rise to Principle C effects.

To fully adopt pronominal markers into an architecture seen in (32), we would have to assume they are either instances of agreement or clitic doubling, and that in the vast majority of cases they agree with or double a null *pro* element merged in an argument position. Between agreement and clitic doubling, I propose that clitic doubling initially presents a more promising model. While more robust evidence is ultimately necessary, one reason to prefer a clitic doubling analysis comes from the fact that pronominal markers exhibit almost no syntactically conditioned allomorphy. Although subject and object markers can exhibit phonologically conditioned allomorphy based on somewhat poorly understood factors such as stress and metrical structure (Crippen 2019), there is no evidence that they show allomorphy based on the syntactic properties of the elements around them. A clear example of this comes from subject markers, which remain consistent regardless of whether or not Aspect is the perfective *wu-* or the null imperfective.

(33) a. Perfective *wu-* (Crippen 2019:562)

Wutuwahein

wu- tu- i- hein
 PFV- 1PLSUB- STV- own
 ‘We claimed it.’

b. Null Imperfective (Crippen 2019:517)

Ituwahéin

i- tu- i- hein
 2SOBJ- 1PLSUB- STV- own
 ‘We own you.’

In both cases, the 1st person plural subject marker *tu-* retains the same shape in spite of a difference in aspect. According to Zwicky and Pullum (1983), this lack of context-sensitive allomorphy can be used as diagnostic for clitics that separates them from agreement. More recent literature on clitics, such as Nevins (2011), questions the validity of this diagnostic, instead proposing a more specific but less extensive requirement of “tense-invariance.” Although Tlingit does not have a robust tense system, it seems that object markers exhibit a similar phenomenon to tense-invariance in that they are “aspect-invariant.” If aspect-invariance is taken to be akin tense-invariance, pronominal markers can ultimately still meet the morphosyntactic diagnostics for being clitics within more recent analyses.

If we propose that pronominal markers are clitics, we must now put forward a viable way to model clitics within the syntax. For this, I believe that the “Big DP” model provides the best approach. According to the Big DP model, pronominal clitics are determiner-like elements base generated alongside the nominal element that they double in an extended (“big”) DP structure. These elements can move out of the DP structure to a distinct place within the clause (Torrego 1992, Uriagareka 1995, van Koppen and van Craenenbroeck 2008, Arregi and Nevins 2012). The internal structure of the extended DP, and the specific projection the clitic is generated in, vary widely depending on the source, but the basic intuition is that the clitic is generated above the nominal, and can inherit the person and case features of that nominal (Arregi and Nevins 2012).

Analyses of how clitics move within the Big DP model also vary widely. If we work within a framework where the Tlingit verbal complex is created via head-movement, it would be most productive to adopt Arregi and Nevins’s (2012) model, whereby clitic movement is also a specific type of head-movement. In particular, clitics can move out of the extended DP structure and adjoin themselves to a certain host, but can skip intervening heads on their way to that host. This movement is motivated by the clitic’s need to check a particular feature. Looking at Basque in particular, for example, Arregi and Nevins (2012) argue that clitics move in order to check a finite [+FIN] feature in the left periphery. Applying this model to Tlingit, we could propose that subject and object markers in Tlingit are clitics that are obligatorily generated in a Big DP structure, where they double null *pro* arguments. Within this structure, they inherit the person, number and case features of the null arguments before moving to another position within the clause for some as of yet unspecified reason. For object clitics in particular, we can straightforwardly propose that they undergo

head movement to Aspect. The movement properties of subject pronominal clitics in this model are less clear, but I abstract away from this for now. The following tree demonstrates an abstraction of the “Big DP” model for Tlingit pronominal markers.

(34) Clitics in a Big DP Model

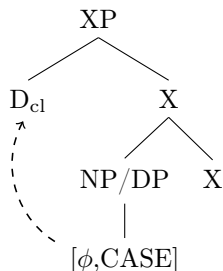

The clitic is generated as a determiner-like element with the category D in an extended nominal structure I mark as XP, so as not to commit to a more specific claim without further analysis. It inherits case and ϕ -features from the nominal deeper down within the XP structure. For the nominals themselves, we can propose that 1st and 2nd person arguments are null *pro* DPs. Because 3rd person singular arguments, regardless of whether they are null or overt, have no pronominal markers, we can also propose that they simply do not generate a clitic within a larger structure.¹⁵ Note that one distinct advantage of this analysis is that it maintains the category D for pronominal markers, without assuming their argument status as Crippen (2019) does.

Ultimately, the status of pronominal markers in Tlingit presents a substantial challenge to any formal analysis of Tlingit syntax. Analyzing them as true arguments has its drawbacks in that it assumes they merge in the same position as independent DPs, without explaining the movement of these DPs to a position outside the verbal complex. Analyzing them as clitics presents a promising theory in several ways, but it ultimately requires much more research and further elicitation to validate. For these reasons, most of the syntactic analyses of Tlingit case alignment put forward in the following sections do not commit to either framework. In discussing certain issues, I attempt to put forward proposals that can make use of both an argument analysis and a clitic doubling analysis, and sometimes comment on which model provides a clear advantage from a theoretical standpoint. In keeping with the terminology I have used up to this point, I will continue to call use the term “pronominal markers” when describing the verbal morphemes that index pronouns.

4 Ergativity in Tlingit: The Basic Properties

With the necessary background information on both ergativity and Tlingit syntax established, I turn towards discussing several aspects of ergativity within Tlingit from both a descriptive and a theoretical standpoint. I begin with a broad overview of the case-alignment properties of the two domains where ergative patterning arises in Tlingit: pronominal markers and independent nouns.

4.1 The Alignment Pattern of Pronominal Markers

As discussed in the introduction, “subject” and “object” markers in Tlingit exhibit a basic pattern of ergative alignment, in that subject markers index transitive subjects, whereas object markers can index both objects and intransitive subjects. From here on, therefore, I will therefore refer to “subject” markers as *ergative* markers, and “object” markers as *absolutive* markers so as to more accurately describe their distribution. As of now, however, I make no assumptions about the locus or assignment of either case.

Upon further examination, it becomes clear that pronominal markers actually exhibit a specific subtype of ergative alignment known as split intransitivity or split-S, discussed earlier in Section 2 (Crippen and

¹⁵This is not necessarily an ad hoc stipulation. Arregi and Nevins (2012) claim for Basque that the generation of clitics is at least partly conditioned by the presence of a Participant phrase (PartP) within a DP. Because 3rd person arguments are not participants, there are some cases where they do not generate clitics.

Déchainé 2015). Instead of a more “standard” ergative pattern whereby transitive subjects are consistently contrasted with intransitive subjects and objects, transitive and *unergative* subjects are contrasted with objects and *unaccusative* subjects. Thus there is a *split* in how single arguments (S) are indexed in intransitive sentences, depending on whether or not they are external arguments with agent-like θ -roles or internal arguments with patient-like θ -roles.

(35) Subject Markers

- a. Transitive Subject (Crippen 2019:523)

Iwtuwaják

i- *w-* **tu-** *i-* *ják*
 2SOBJ- PFV- 1PLSUB- STV- kill

‘We killed you.’

- b. Unergative Subject (Crippen and Déchainé 2015:5)

Wutuwakoox

wu- **tu-** *i-* *koox*
 PFV- 1PLSUB- STV- boat

‘We boated.’

(36) Object Markers

- a. Transitive Object (Crippen 2019:700)

Haa yisiteen

haa= *wu-* *i-* *s-* *i-* *teen*
 1PLOBJ= PFV- 2PLSUB- XTN- STV- see

‘You saw us.’

- b. Unaccusative Subject (Crippen and Déchainé 2015:5)

Haa woonaa

haa= *wu-* *i-* *naa*
 1PLOBJ= PFV- STV- die

‘We died.’

Although the alignment system of pronominal markers exhibits a split based on semantic type, there is no genuine evidence that pronominal markers show any of the other splits discussed in Section 2. The pattern seems to remain the same across all aspects, the most basic example being consistency across the perfective, expressed by *wu-*, and the null imperfective.

(37) Consistency Across Aspects

- a. Null Imperfective (Crippen 2019:517)

Itoohóon

i- **tu-** *hoon*
 2SABS- 1PLERG- sell

‘We sell you (impf.)’

- b. Perfective *wu-* (Crippen 2019:523)
 Iwtuwaják
i- wu- tu- i- ják
2SABS- PFV- **1PLERG-** kill
 ‘We kill you (pfv).’

Both (37a) and (37b) make use of the same set of pronominal markers, in the same position, to indicate the 2nd person object and the 1st person transitive subject. Determining whether or not pronominal markers exhibit a split based on person is less straightforward, as most 3rd person subject and object pronouns are both expressed through null *pro* arguments (Crippen 2019). Nevertheless, there appears to be evidence against a split when transitive constructions with a single 3rd person argument are considered. To express a meaning in which a 3rd person entity is an object, with 1st or 2nd person transitive subjects, the subjects are always expressed through the ergative marker. Likewise, when 3rd person transitive subjects appear with 1st or 2nd person objects, the objects are always expressed through the absolutive marker. This demonstrates, at the very least, that the presence of a 3rd person argument has no effect on the pronominal marking of 1st and 2nd person arguments – something which would be unexpected if 3rd person arguments triggered a different type of alignment.

(38) Consistency Across Persons

- a. 1st Person Subject, 3rd Person Object (Crippen 2019:719)

Wutusiteen
wu- tu- s- i- teen
 PFV- **1PLERG-** XTN- STV- see
 ‘We saw him/her/it.’

- b. 3rd Person Subject, 1st Person Object (Crippen 2019:719)

Haa wusiteen
haa= wu- s- i- teen
1PLABS= PFV- XTN- STV- see
 ‘He/she/it saw us.’

Given the lack of evidence for any splits in case alignment pattern based on aspect or person, I conclude that pronominal markers in Tlingit exhibit a consistent split intransitive pattern of case alignment within the verbal complex. I now turn to the alignment properties of independent nominals.

4.2 The Alignment Pattern of Independent DPs

Outside of the verbal complex, independent DPs also display a pattern of ergative alignment. Interestingly, however, this pattern differs from the split intransitivity observed within the verbal complex. Transitive subjects, marked by the suffix *-ch*, are contrasted from transitive objects and intransitive subjects, with *no apparent split between unergatives and unaccusatives* (Crippen 2011).

(39) Independent DPs

- a. Transitive (Crippen 2011:20)

A_x éeshch útlxi as.ée
a_x éesh-ch útlxi a- s- i
 1SGPSS father-**ERG** soup 3ON3- CSV- cook
 ‘Father is cooking soup.’

- b. Unaccusative (Crippen 2011:23)

X'alchán yanéekw
X'alchán i- níkw
 X'alchán STV- sick
 'X'alchán is sick.'

- c. Unergative (Crippen 2011:20)

X'alchán woogoot
X'alchán wu- i- gut
 X'alchán PFV- STV- go
 'X'alchán went.'

In (29a), the transitive subject *éesh* 'father' is marked by the ergative suffix *-ch*, and the object *útlxi* exhibits a zero-marked absolutive case. Both the unaccusative and unergative subject in (39b) and (39c) also exhibit the zero-marked absolutive case, in spite of the fact that the motion verb *gut* 'go' uses overt ergative pronominal markers when the subject is 1st or 2nd person (Crippen 2011). This demonstrates that the ergative alignment on independent nominals is substantially different from that pronominal markers, as it is not split intransitive.

In spite of the fact that ergative marking on independent nominals behaves more like the canonical pattern, with all intransitive single arguments receiving absolutive, there are several additional facts that complicate this. Most prominent of all is the fact that the ergative marker *-ch* does not appear in reflexives. Reflexives in Tlingit can be analyzed as underlyingly transitive, as they typically use ergative pronominal markers in combination with an overt anaphor *sh* that appears in the object position.

- (40) Reflexive with Ergative Marker (Crippen 2019:352)

Sh wutudihoon
Sh= wu- tu- d- i- hoon
 REFL= PFV- **1PLERG**- MID- STV- sell
 'We sold ourselves.'

Given these facts, one would expect *-ch* to appear on reflexive transitive subjects, but it does not.

- (41) Reflexives

- a. X'alchán sh dzixán (Crippen 2011:22)

X'alchán sh d- s- i- xán
 X'alchán REFL MID- CSV- STV- love
 'X'alchán loves himself.'

- b. *X'alchánch sh dzixán (Crippen 2011:22)

X'alchán -ch sh d- s- i- xán
 X'alchán **-ERG** REFL MID- CSV- STV- love
 Intended: 'X'alchán loves himself.'

Moreover, the ergative suffix *-ch* also fails to appear in transitive constructions when the direct object is indefinite, as shown below.

(42) Indefinite Object - No Ergative Marker

(Crippen 2011:22)

A_x éesh t'a awsit'éx

a_x éesh t'a a- wu- s- i- t'éx
1SG.PSS father king.salmon.INDEF 3ON3- PFV- CSV- STV- fish
'My father was fishing for king salmon.'

4.3 Tlingit is not Syntactically Ergative

When considering operations such as A'-movement in Tlingit, it is clear that the language displays few of the properties associated with syntactic ergativity as laid out in Section 2, and is likely better characterized as purely morphologically ergative. Recall from Section 2 that syntactically ergative languages generally exhibit a ban on extracting transitive subjects for A'-operations such as relativization and wh-movement. In contrast with these languages, Tlingit seems to allow both transitive subject and object extraction with gaps, in both relative clause constructions and wh-movement. Crippen (2012) gives the following examples for relativization.

(43) Transitive Subject and Object Relativization

a. Object Relativization

(Crippen 2012:8)

Wé Yéilch kaawanóot'i éech'

[*wé Yéil -ch _abs ka- wu- i- nut' -i*] *éech'*
[MDST Raven -ERG _ HSFC- PFV- STV- swallow -REL] **rock**
'that rock that Raven swallowed'

b. Transitive Subject Relativization

(Crippen 2012:8)

Wé éech akaawanut'i káa

[*_erg wé éech a- ka- wu- i- nut' -i*] *káa*
[_ MDST rock 3ON3- HSFC- PFV- STV- swallow -REL] **man**
'that man who swallowed the rock'

In (43a), the object *éech'* 'rock' can be relativized, and likewise in (43b) the transitive subject *kaa* 'man' can also be relativized. This indicates that, within the relative clause, the operator indexing both the object and the transitive subject can undergo movement to a position within the embedded CP. Turning towards wh-movement, extraction of both transitive subjects and objects is also possible (Cable 2007).

(44) Wh-Movement

a. Object Wh-Movement

(Cable 2007:64)

Daa sá kéet a- xa
What Q killerwhale 3on3- eat
'What do killerwhales eat?'

b. Transitive Subject Wh-Movement

(Cable 2007:64)

Aadóo -ch sá yá x'úx' akugwatóow
Who -ERG Q this book.ABS 3on3.FUT.read
'Who will read this book.'

To summarize the basic patterns of ergative alignment in Tlingit, pronominal markers exhibit split intransitivity, something which is contrasted with a more canonical ergative alignment in independent nominals.

Tlingit seems to exhibit no bans on moving transitive subjects for purposes of A'-movement, and thus does not appear to be syntactically ergative.

With the basic properties of ergative-absolutive alignment in Tlingit established from a descriptive standpoint, I now turn towards exploring these properties from a theoretical standpoint. I begin by first discussing theoretical issues associated with absolutive pronominal markers, followed by ergative pronominal markers. I then discuss the issues that arise when one considers the different properties of ergative marking on pronominals and independent nouns. In each section, I offer either one or several potential syntactic analyses based on the existing literature. It is worth mentioning that in several instances I explicitly work within a Distributed Morphology (DM) style architecture of grammar (Halle and Marantz 1993, 1994). In particular, I assume that most morphemes correspond to Vocabulary Items (VIs) that express terminal nodes in a syntactic tree, but are inserted in a post syntactic mechanism. Vocabulary Items are specified for certain feature bundles, and can be inserted to express a terminal node if they match all of that terminal node's features or a *subset* of its features (Halle and Marantz 1993, 1994).

5 Discerning the Case Properties of Absolutive Markers

I begin my exploration of the theoretical issues surrounding case alignment in Tlingit with a discussion of the case properties of absolutive markers. Absolutive markers raise several questions due to their relatively high position within the Tlingit verbal complex, and the extent to which absolutive case assignment is related to this position. The implications of these questions – and the nature of the potential solutions – differ radically depending on whether one adopts a true argument analysis or a clitic doubling analysis of pronominal markers. I ultimately suggest that a clitic doubling analysis works better to model absolutive markers, at it allows us to separate their case properties from their movement properties.

5.1 The “High” Position of Absolutive Markers and Challenges to an Argument Analysis

Recall from Section 3 that absolutive markers surface much further from the verb root than ergative markers within the verbal complex, often to the left of an aspectual marker such as *wu-*.

(45) Absolutive Markers Farther from Root (Crippen 2019:523)

Iwtuwaják
i- wu- tu- i- ják
2SABS- PFV- 1PLERG- kill
 ‘We kill you (pfv).’

In an analysis that treats the Tlingit verbal complex as an entire clause in which pronominal markers are DP-like arguments, the position of absolutive markers can be taken to be a pretty transparent indication that the case licensing of the absolutive is related Aspect, and thus occurs in a “high” position. Crippen (2019) theorizes that absolutive markers move from a VP internal position to the specifier of Aspect for phonological reasons – although he does not rule out the possibility that the movement could indeed be related to case, as several absolutive markers are short enough so as not to warrant movement purely for phonological reasons, but nevertheless move anyway.

If we more firmly adopt the basic assumption that absolutive markers move to the specifier of Aspect for case licensing purposes, we can very straightforwardly model the “absolutive” case in Tlingit as being akin to the nominative. That is to say, transitive objects and unaccusative subjects are not assigned case within the vP domain, but are instead assigned absolutive case by Aspect, which constitutes the high inflectional head in Tlingit. In a model such as this, transitive objects and unaccusative subjects would have to minimally move to the edge of a vP phase, past a transitive subject, in order receive case (Coon et al. 2014, Aldridge 2008, 2004). If we further postulate that Aspect in Tlingit has an [EPP] feature that draws DPs into its specifier, we could then fully derive the absolutive markers’ position before Aspect. As for the ergative, one could initially model it as being assigned lower in the clause – perhaps as an inherent case assigned by little *v*. The following tree demonstrates this potential model.

(46) Absolutive Case Assignment from Aspect

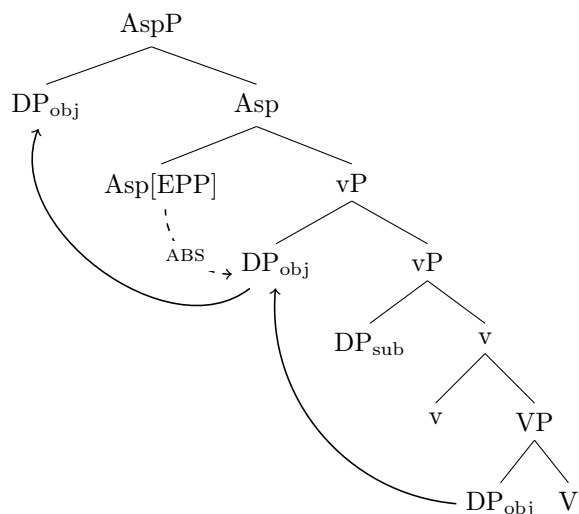

While a model such as the one above could provide a good account for the basic order of morphemes within the Tlingit verbal complex, it runs into several theoretical issues when other factors are taken into account.

5.1.1 An [EPP] Feature Overgenerates

On a very basic level, an [EPP] feature on Aspect works well to derive the position of absolutive markers immediately before it. Moreover, if we postulate that object DPs move above subject DPs within vP, we would predict absolutive markers move to Aspect instead of subject markers, as they would be the first arguments visible to an [EPP] feature. In spite of these advantages, however, an [EPP] feature on Aspect makes several incorrect predictions. Abstracting away from the relationship between [EPP] and case, we may simply expect an [EPP] feature on Aspect to attract ergative markers to its specifier in single argument unergative constructions, as there would be no higher object argument available. This prediction is not born out, however. Ergative markers remain within the vP in unergatives, or at the very least do not move to a position before Aspect.

(47) Ergative Markers Remain in vP

(Crippen 2019:262)

Wutuwaxéix'w

wu- **tu-** i- x'ex'w

PFV- **1PLERG-** STV- sleep

'We slept.'

Moreover, in the absence of an absolutive marker to attract, one might expect an expletive to show up in the specifier of Aspect to fulfill an EPP feature. As the above example shows, this clearly is not born out either.

5.1.2 Incorrect Predictions about Syntactic Ergativity

Several recent strands of analyses claim that languages in which the absolutive case is licensed by a high inflectional head ought to exhibit syntactic ergativity in the form of a ban on A'-movement for transitive subjects (Aldridge 2004, 2008, Coon et al. 2014, Assmann et al. 2015). Initially mentioned in Section 2, Coon et al. (2014) claim that syntactic ergativity emerges in languages with a high locus of absolutive case due to the movement of absolutive DPs. Assuming that a transitive vP constitutes a phase, they propose that DPs not assigned ergative case (inherent in their model) must move past the transitive subject to a

higher specifier in vP, so as to be still visible to a high inflectional head for absolutive case assignment. The movement of the absolutive marker to this position traps transitive subjects within vP, rendering them unable to move in A'-operations (Coon et al. 2014).

Going in the opposite direction, Assmann et al. (2015) claim that syntactic ergativity in languages with high absolutive case-licensing results from the movement of transitive subjects. Assuming that Tense is the locus of absolutive case, and that A'-movement of any DP must proceed through Tense in order to get to [spec, CP], they claim that transitive subjects are prohibited from A'-movement because moving through Tense will essentially “rob” a non-ergative object of a case licensor. That is to say, movement of an ergative subject through Tense will prevent tense from case-checking an object, thus causing any derivation to crash (Assmann et al. 2015).

Although different in the mechanics of how the high licensing of absolutive case prevents ergative extraction, both analyses clearly predict that licensing absolutive case from a head like Asp should lead to syntactic ergativity. This is clearly not the case in Tlingit, however, as it freely allows A'-movement of both transitive subject and object DPs with gaps.

(48) Wh-Movement

- a. Object Wh-Movement (Cable 2007:64)

Daa sá kéeet a- xa
 What Q killerwhale 3on3- eat
 ‘What to killerwhales eat?’

- b. Transitive Subject Wh-Movement (Cable 2007:64)

Aadóo -ch sá yá x'úx' akwwatóow
 Who -ERG Q this book.ABS 3on3.FUT.read
 ‘Who will read this book.’

The lack of syntactic ergativity does not fall out from a model whereby the absolutive case in Tlingit is assigned by Aspect. On a broad level, this presents a substantial challenge within any architecture of the Tlingit verbal complex where pronominal markers are DP-like structures merged in an argument position. Absolutive pronominal markers appear to the left of Aspect, and for all intents and purposes seem as if they have moved from a position within VP to the specifier of Aspect. The most readily available initial explanation is that they move to Aspect to receive absolutive case, yet Tlingit does not exhibit several of the A'-properties of a language where absolutive case is licensed higher than the vP level.

5.2 The Clitic Analysis and Default Case

In the previous section we discussed some of the theoretical issues associated with the seemingly “high” position of absolutive case licensing, in addition to difficulties these issues created in an analysis where pronominal markers constitute true arguments. We will now address the same issues within a framework where pronominal markers are treated clitics.

5.2.1 The Initial Advantages of a Clitic Analysis

In discerning the case properties of the absolutive markers in Tlingit, one of the biggest advantages in treating them as clitics is the fact that their surface position no longer needs to be as intimately tied to case.¹⁶ Recalling the analysis of clitics in Section 2, if we adopt a Big DP model along the lines of Arregi and Nevins (2012), we could tentatively propose that absolutive markers reflect the case properties of the arguments they co-index, but move to a position near Aspect for *independent reasons*. In this way, absolutive case on DPs does not need to be associated with Aspect in any way – it could theoretically come from a completely different locus, with overt forms that reflect absolutive case surfacing near Aspect for reasons purely related to clitic movement.

¹⁶Note that there are some analyses of clitics which do tie their surface positions to case. See Savescu-Ciucivara (2009) for Romanian.

5.2.2 Alternative Loci of Absolutive

If absolutive case does not need to be licensed by Aspect under an analysis where pronominal markers are clitics that move to Aspect for separate reasons, there are several alternative possibilities for discerning the locus of absolutive case. The first alternative is that absolutive in Tlingit is actually akin to the *accusative* – a structural case assigned by little *v*. This would easily explain why absolutive markers index transitive objects. More importantly, however, placing the locus of absolutive case low within the clausal architecture would do away with all the issues associated with a high locus of absolutive case and a lack of syntactic ergativity. In fact, Tlingit would be expected *not* to exhibit syntactic ergativity. If absolutive is assigned by little *v*, it has no reason to escape the vP layer for case checking reasons, thus “trapping” the ergative subject (Coon et al 2014). Likewise, an ergative subject moving into [spec, TP] on its way to CP would not “rob” the absolutive object of a case assigner, causing the derivation to crash, as the object would have already received case from little *v* (Assmann et al 2015).

One drawback to making the locus of absolutive case little *v*, however, is that it requires some stipulations about the structure of unaccusatives in Tlingit. If unaccusative subjects are internal arguments base-generated in VP, there is no genuine need for an additional little *v* layer in the structure, as there is no external argument. Crippen (2019), for example, does not assume a little *v* layer for unaccusatives. If we take little *v* to assign absolutive case, however, then we are forced to postulate a little *v* layer even in unaccusatives, so as to derive absolutive case on unaccusative subjects. In particular, this specific type of little *v* would not introduce an external argument, but instead exist solely to assign absolutive case. While the existence of an “unaccusative” little *v* that does not introduce an external argument is a relatively common assumption, the idea that an unaccusative little *v* can assign case is much rarer. It is not unheard of, however, as Rezac et al. (2014) adopt this exact analysis for unaccusatives in Basque. Considering a basic transitive, the following tree shows how a absolutive case assignment from little *v* would work in Tlingit under a clitic analysis. Note that this tree, and the trees below, assume head movement of V to little *v* to Aspect, but only show clitic movement.

(49) Clitic Movement - Little *v* Assigns Absolutive

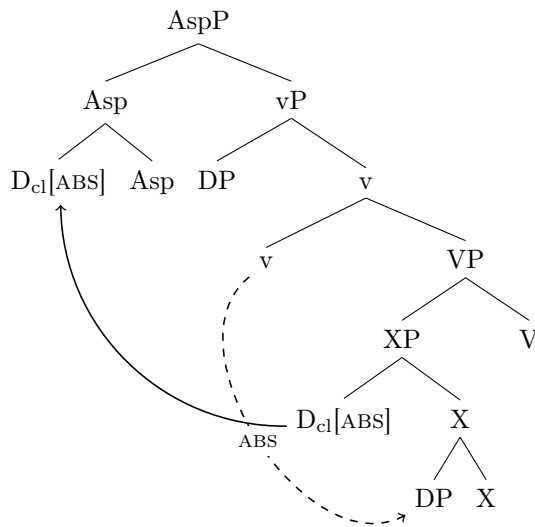

The transitive object would receive absolutive case from little *v*. Adopting a Big DP analysis, a clitic in some projection immediately above DP would inherit these absolutive case features, and undergo head-movement to Aspect. This derives the correct order of morphology within the verbal complex while also modeling the absolutive as a case assigned lower than Aspect in the structure.

A second potential alternative is to propose that “absolutive” clitics in Tlingit really reflect *two* cases: nominative and accusative, and therefore that Tlingit is an ABS=DEF language in the sense of Legate (2006, 2008). Recall from Section 2 that Legate analyzes the absolutive case in ABS=DEF languages as a

purely morphological phenomenon, as opposed to a syntactic primitive. Rather than being a case assigned in the syntax, the absolutive is merely a descriptive term for an unmarked instance of default morphology assigned to DPs that are underlyingly nominative or accusative, in the event that a language lacks specific morphological markers for either case. This analysis is readily applicable to Tlingit, if we propose that absolutive clitics are actually default clitics. In particular, we could propose that transitive objects and unaccusative subjects have different underlying cases, with the former receiving accusative case from little *v*, and the latter receiving nominative case from *Asp*. The clitics that cross-reference these nominative and accusative DPs are the same, however, only because Tlingit lacks specific Vocabulary Items for nominative and accusative clitics. In the absence of these specific Vocabulary Items, default clitics, which are only specified for person and number, are used instead. The Vocabulary Items below demonstrate the featural specifications of these default clitics.

(50) Vocabulary Items for Default Clitics

Vocabulary Item	Inserted For
[D,+1,-pl] -> /xat-/	[D,+1,-pl,NOM], [D,+1,-pl,ACC]
[D,+2,-pl] -> /i-/	[D,+2,-pl,NOM], [D,+2,-pl,ACC]
[D,+1,+pl] -> /haa-/	[D,+1,+pl,NOM], [D,+1,+pl,ACC]
[D,+2,+pl] -> /yi-/	[D,+2,+pl,NOM], [D,+2,+pl,ACC]

If we adopt these Vocabulary Items for default clitics, we can model “absolutive” case assignment in Tlingit syntax as either nominative case assignment in unaccusatives, or accusative case assignment in transitives. The following trees demonstrate.

(51) Clitic Movement - “Absolutive” is Default Morphology

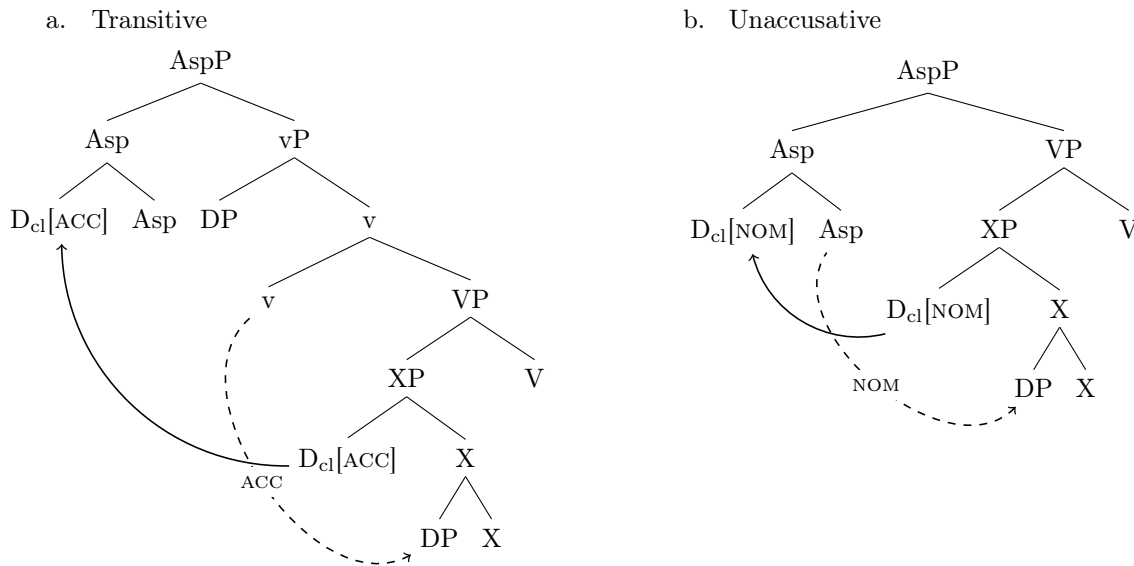

In the transitive (51a), little *v* assigns accusative case to an object, which generates an underlyingly accusative clitic that undergoes head movement to Aspect. In (51a), Aspect assigns nominative case to the unaccusative subject, generating a nominative clitic that undergoes head movement to Aspect. Lacking specific Vocabulary Items for nominative or accusative clitics, Tlingit spells out both types of clitics with the underspecified morphological defaults in (50). Similar to an analysis in which so-called “absolutive” clitics really reflect accusative case, the default analysis is also desirable in that it does not predict syntactic

ergativity. Since transitive objects still receive underlying accusative case from little *v* in the default analysis, there is again no need for them to escape the *vP* layer in order to receive case, trapping the transitive subject.

In general, analyzing pronominal markers as clitics in a Big DP model has a distinct advantage in that it allows us to model their case properties in a way that is separate from their movement properties. This opens the door for plainly analyzing absolutive markers as reflecting accusative case, or being morphological defaults for both nominative and accusative. Ultimately, however, adopting a clitic analysis within the Big DP model also requires us to put forward an independent reason for clitic movement to Aspect. As of now, I have no concrete proposal for what motivates this movement. If we assume, following Arregi and Nevins (2012), that clitics in Tlingit need to move to Aspect to check a feature, one potential answer is to propose that they move to check a *conjugation* feature in Aspect. Recall from Section 2 that the Aspect subtree in Tlingit can often contain a node specifying a certain conjugation class, which is either determined lexically or syntactically. Perhaps one could propose absolutive clitics in Tlingit are merged with an unchecked conjugation feature that can only be checked through adjoining to an Aspect head that bears a conjugation feature in its subtree. I ultimately leave this question open for now.

It is also worth noting that if clitics undergo movement from the *vP* domain to Aspect, one could potentially claim that syntactic ergativity is still predicted to arise. If *vP* is a strong phase, clitics would also need to move above subjects to the specifier of *vP* in order to have access to Aspect, thereby trapping the subject in a Coon et al. (2014) style analysis. I suggest that the best way to circumvent this is to propose that *vP* is a weak phase in Tlingit, and to adopt Assmann and others' (2015) analysis of syntactic ergativity. As a weak phase, *vP* does not block movement. Because objects are assigned case by little *v* in Tlingit, syntactic ergativity does not arise because the movement of transitive subjects cannot rob the object of a case assigner (Assmann et al. 2015).

Overall, the position of absolutive markers, in addition to the unclear syntactic nature of absolutive markers, makes their detailed case properties quite difficult to analyze. An analysis whereby the absolutive is akin to the nominative works somewhat well to explain morpheme order, but leads to an unrealized prediction of syntactic ergativity if pronominal markers are treated as arguments as opposed to clitics. Adopting a clitic doubling model of pronominal markers ultimately allows for more freedom, as the properties associated absolutive case can be dissociated from the movement properties of absolutive markers. With various proposals for the nature of absolutive case in Tlingit established, I now turn towards analyzing various dimensions of the ergative case.

6 The Dual Nature of Ergative Markers

In the following two sections, I look into and analyze the various properties associated with the ergative case in Tlingit, examining both ergative pronominal markers and the ergative clitic *-ch* discussed in Section 4. In this first section, I begin with some of the theoretical puzzles associated with ergative pronominal markers within the verbal complex, specifically focusing on their simultaneous structural and inherent case properties, and offering several analyses that can account for this pattern.

6.1 The Case Properties of Ergative Markers

In Section 2, I established that there are several prominent – and often competing – analyses of the locus of ergative case. Some researchers take it to be a structural case akin to the nominative, assigned by a high inflectional head (Bobaljik 1993, Rezac et al. 2014), whereas others take it to be an inherent case, associated with an external argument θ -role assigned by a little *v* head (Woolford 1997, 2006). Beyond this there are also dependent case accounts, which propose that ergative case is given to a DP when it c-commands another DP within a relevant domain (Marantz 1991, Baker 2015, Baker and Bobaljik 2017).¹⁷ Ergative markers in Tlingit present a theoretical challenge in that they seem to exhibit the properties associated with both structural *and* inherent case.

Recall from Section 4 that pronominal markers in Tlingit exhibit split-S alignment. This means that ergative markers index both transitive and unergative subjects, as seen in the following examples repeated

¹⁷It should be noted that its original formulation, dependent case was also a technically a structural case, in that it was still assigned by assigned by the functional head “verb + inflection” or “*v+I*” (Marantz 1991).

from (35).

(52) Ergative Markers

a. Transitive Subject

(Crippen 2019:523)

Iwtuwaják

i- w- tu- i- ják
 2SABS- PFV- **1PLERG-** STV- kill
 ‘We killed you.’

b. Unergative Subject

(Crippen and Déchaine 2015:5)

Wutuwakoox

wu- tu- i- koox
 PFV- **1PLERG-** STV- boat
 ‘We boated.’

Right away, this data presents a challenge to any analysis whereby ergative markers reflect dependent ergative case. Under a dependent case analysis, ergative is assigned to a DP only when it c-commands another DP (Marantz 1991, Baker and Bobaljik 2017). This predicts that the subjects of single argument unergatives *should not* receive ergative case, as there is no DP lower in the structure, and yet unergatives in Tlingit consistently make use of the ergative marker. One could potentially work around this by proposing that unergative predicates actually contain *covert* internal arguments (Bobaljik 1993), and therefore that unergative subjects really do c-command another DP in the syntax, but in the absence of further evidence I do not consider this possibility further.

On the other hand, a split-S pattern is much more amenable to an analysis whereby the ergative is an inherent case. If we adopt the assumption that both transitive and unergative subjects are external arguments merged outside of the VP in the specifier of little v (Chomsky 1995, Kratzer 1996), one could straightforwardly propose that ergative markers in Tlingit reflect inherent case on external arguments licensed by a little v head. Because unergatives are intransitive, we would not even be required to stipulate a transitivity condition on little v (Woolford 2006, Legate 2012). Moreover, adopting this analysis would produce a neat contrast with unaccusative subjects. Assuming that unaccusative subjects differ from unergative subjects in that they are merged lower within the VP, it follows that they could not receive inherent ergative case from any little v head, and would therefore manifest instead as either nominative or accusative, depending on the analyses put forward in Section 5. The following trees represent the case assignment patterns for transitive and unergative subjects in Tlingit under an inherent case analysis.

(53) Inherent Case Analysis

a. Transitive Subject

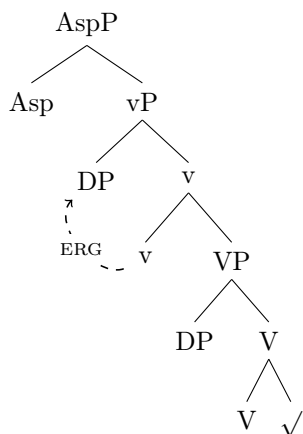

b. Unergative Subject

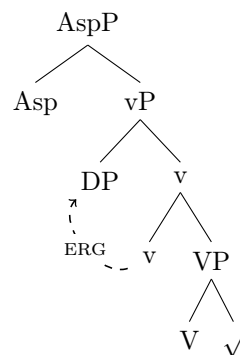

While an inherent case analysis works well with relatively simple transitive and unergative clauses, an inherent theory of ergative case makes several incorrect predictions for ergative markers in Tlingit when more complex structures are considered. Moreover, the behavior of ergative markers within these constructions is better modeled by a *structural* theory of ergative case.

6.1.1 Ergative Markers Disappear in Causatives

Structural and inherent theories of the ergative case make different predictions about what configurations the ergative case should be preserved in, particularly when it comes to ECM-like constructions (Rezac et al. 2014). Structural theories, in which the ergative is licensed by a high inflectional head, predict that external arguments typically marked ergative should exhibit exceptional case-marking when they do not have access to a high inflectional head (Rezac et al. 2014). Inherent theories, on the other hand, predict that ergative external arguments should be immune to ECM, as they are associated with a θ -role assigned by little *v* independent of an inflectional head.

One particularly salient domain for exploring this difference is the behavior of external arguments embedded in causative constructions. Following Pyllkanen (2002, 2008), suppose that causatives have the following basic structure, in which causative morphology is introduced by a Causative phrase (CausP), and the structure embedded within CausP maximally projects up to a little *v*P that introduces an external argument causee.¹⁸

(54) Structure of Causative

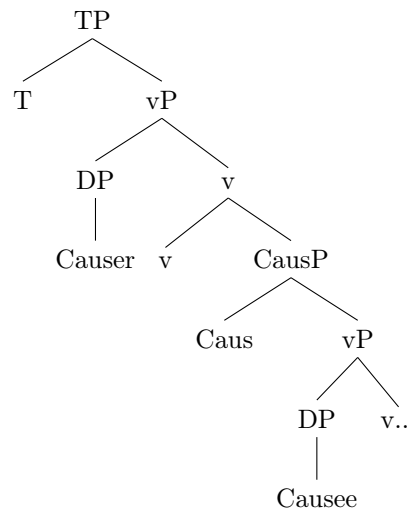

In a structure such as (54) the inherent ergative analysis predicts that both the causer and the causee should receive ergative case, as both are external arguments introduced in little *v*P. In contrast to this, a structural theory predicts that the causee should lose ergative case, as it is too far away from a high inflectional head such as T, which would instead assign ergative to the closer causer argument. The example below demonstrates that the *structural* theory makes the right predictions for Tlingit, as external argument causees *do not* retain ergative case, but are instead indexed by absolutive markers.

- (55) a. Unergative Subject (Crippen 2019:262)
 Wutuwaxéix'w
 wu- **tu-** i- x'ex'w
 PFV- **1PLERG-** STV- sleep
 'We slept.'

¹⁸Note that Pyllkanen (2002, 2008) uses the label “Voice” for the external argument introducing head. Moreover, she proposes that in many languages Caus and Voice can be bundled together (2002, 2008).

b. Causativization of (55a)

(Crippen 2019:282)

Haa yeeysixéix'w

haa= *wu-* *yi-* *s-* *i-* *x'ex'w*

1PLABS= PFV- 2PLERG- CSV- STV- sleep

‘You made us sleep.’

In (55a), the external argument of the unergative verb *x'ex'w* ‘sleep’ is expressed through the 1st person plural ergative marker *tu-*. In (55b), the unergative undergoes causativization, and the external argument of *x'ex'w*, now embedded as a causee, is expressed by the 1st person plural absolutive marker *haa=* instead. The only argument indexed by an ergative marker is the causer.

Because the ergative marker fails to index the external argument causee in (55b), it becomes much more difficult to argue that ergative markers in Tlingit are simply expressions of inherent ergative case assigned by little *v*. Their appearance also seems to be dependent on a high inflectional head – in the case of Tlingit Aspect – which is more indicative of structural case. In this way, ergative case in Tlingit exhibits a dual nature, with both structural and inherent case properties. In the section below, I offer several potential analyses that can account for this phenomenon.

6.2 Towards a Tentative Analysis

There are various analyses that can provide a solution for the conflicting inherent and structural case properties of ergative markers in Tlingit, three of which I outline here. The first analysis is to maintain that ergative markers reflect inherent case regardless of the fact that they disappear in causatives, whereas the second is to claim that ergative markers fully reflect structural case from Aspect. A third and final analysis is to propose that both Aspect and little *v* have a combined role in ergative case assignment. For the most part, all three proposals are compatible with ergative markers in Tlingit being either full argument DPs or doubled clitics.

6.2.1 Ergative is Inherent, Causees Receive a Different Case

The first solution to the issues outlined above is to maintain that the ergative is still an inherent case, but that external argument causees are not actually merged in a position where they receive this case. An analysis along these lines essentially claims that the structure of Tlingit causatives is distinct from that in (54), specifically with regards to where the causee is merged. In adopting a different structure for causatives than Pytkkanen (2002, 2008), one could look towards a prominent strand of analyses which proposes that embedded external argument causees are not merged in vP, but instead in the specifier of an Applicative (Appl) phrase, as demonstrated below (Ippolito 2000, Kim 2011, Nie 2016).

(56) Causatives with Applicatives (Ippolito 2000, Kim 2011, Nie 2016)

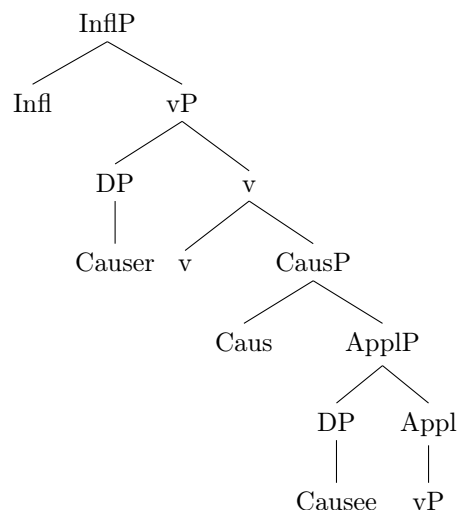

If we adopt a version of structure above for Tlingit causatives, the fact that absolutive markers index external argument causees instead of ergative markers poses almost no problem for an inherent case analysis. While inherent ergative case is naturally assigned to external arguments in matrix clauses by little *v*, embedded external arguments introduced in ApplP are never in a position to receive inherent ergative, as they are not merged in [spec, vP], and perhaps associated with a less agentive θ -role. Instead, they receive a different case, potentially from Appl.

The inherent case proposal is largely applicable to both a full argument or a clitic doubling analysis of pronominal markers. If pronominal markers are DP-like arguments, we can straightforwardly claim that they are pronouns with inherent ergative case. As for causees, we could claim that they are pronouns with dative case from Appl, but that the spell-out of dative and absolutive pronouns is the same. We could likewise argue that ergative markers are clitics which reflect inherent ergative case features from a full DP. If we build off of our claim in Section 5 that absolutive clitics are really default clitics, we could additionally propose that causees receive dative case from Appl, but are indexed with defaults because Tlingit lacks specific Vocabulary Items for dative clitics. The tree below demonstrates one potential structure for a Tlingit causative, assuming inherent ergative case assignment and clitic doubling.

(57) Inherent Ergative, Causees Introduced by Appl

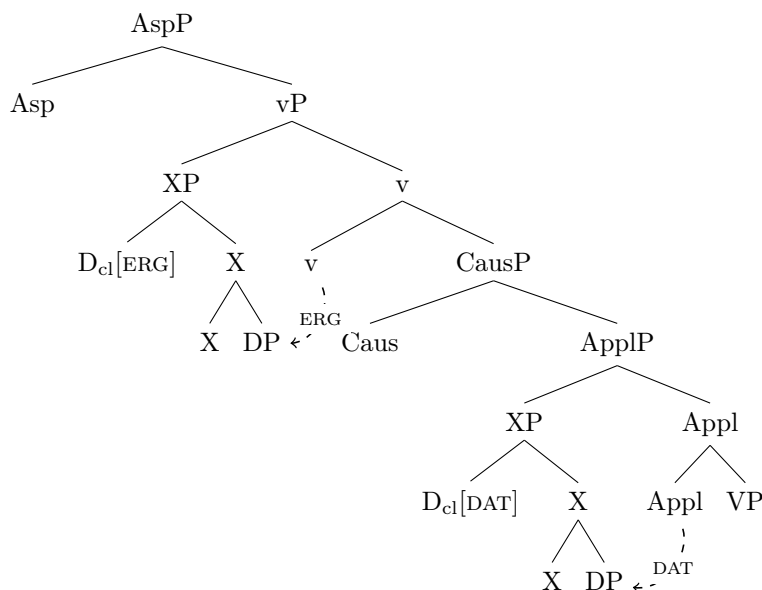

The causer DP is an external argument that receives inherent ergative case from the matrix little *v*. This generates an ergative clitic in an extended Big DP structure. The causee is merged in [spec, Appl], where it receives dative case. This generates another clitic which inherits the ϕ -features and case features of the causee in the syntax, but is exponed through a default clitic in the morphology.

Overall, an inherent case account for Tlingit ergative markers can still be maintained if we assume that external argument causees are not introduced in *vP*, but in a distinct structure such as ApplP. However, the claim that causees are introduced by ApplP as opposed to *vP* warrants further evidence, something which I cannot provide at this time.

6.2.2 Ergative Is Structural

Going in the opposite direction of the analysis in the previous section, one could also propose that the ergative in Tlingit is a structural case assigned by Aspect. If we adopt the analysis of causatives in (54), a structural theory of ergative case most transparently explains the fact that absolutive markers index external argument causees. Within a causative, the embedded external argument does not have access to ergative case assignment from Aspect, and instead receives absolutive case through one of the various mechanisms specified in Section 5.

Adopting a structural analysis for the Tlingit ergative case necessitates making several further claims about the Aspect head that assigns it. Regardless of whether we adopt a true argument analysis or clitic doubling analysis of pronominal markers, we would likely have to posit that Aspect in Tlingit does not have an [EPP] feature that draws ergative subjects into its specifier. In contrast to absolutive markers, there is almost no positive evidence that ergative markers undergo any sort of movement from the *vP* layer to Aspect, and indeed Crippen (2019) proposes that ergative subjects largely remain in situ.¹⁹ Taking this into account, the following tree represents the basics of structural ergative case assignment in Tlingit.

¹⁹In constructions with the “Voice” head *d-*, Crippen (2019) does propose that ergative subjects undergo short distance movement from *v* to Voice.

(58) Structural Ergative Case

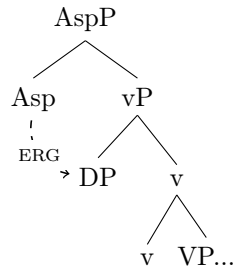

Without an [EPP], Aspect in Tlingit would stand apart from an analogous structural case-assigning head such as T in English, as Aspect would merely assign structural case without drawing anything into its specifier. Overall, this analysis of Aspect works well with the claim in Section 5 that an [EPP] feature overgenerates. It is worth noting, however, that in an analysis where pronominal markers are DP-like arguments, we would have to propose an independent reason for the movement of absolutive DPs to Aspect, something which could not be reduced to clitic movement.

Delineating the featural specifications of Aspect becomes more complicated when we consider unaccusatives. If we take ergative to be a structural case assigned by Aspect, one might expect Aspect to assign the ergative to unaccusative subjects, as there are no other arguments in the derivation for Aspect to establish an Agree relation with and assign a case feature to. One way of circumventing this is to propose, following Section 5, that unaccusative subjects receive absolutive case from little *v*, and therefore that Aspect simply fails to assign a case feature to an argument that already has one.

Another solution is to propose that Tlingit actually has two distinct Aspect heads: Asp_{ERG} and an underspecified Asp. Asp_{ERG} is merged in transitive and unergative constructions, where it assigns an ergative case feature to external arguments. Underspecified Asp is merged in unaccusatives, where it does not assign any case feature, with unaccusative subjects receiving case from little *v*. A proposal along the very same lines is made by Rezac et al. (2014) for Tense in Basque – a language which also has split-S alignment and absolutive causees.²⁰ Alternatively, underspecified Asp could really be Asp_{NOM} which assigns nominative case to unaccusative subjects. If we adopt a default clitic analysis in particular, these underlyingly nominative subjects would be expressed through the same clitics as underlyingly accusative objects. Abstracting away from whether or not pronominal markers are arguments or clitics, the following trees demonstrate one potential model of the different case assignment properties of Aspect in Tlingit, highlighting the difference between an unergative and an unaccusative sentence.

(59) a. Unergative

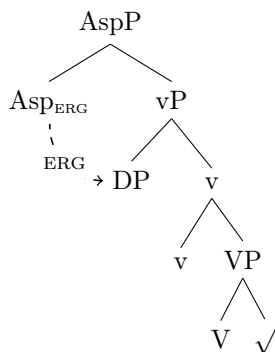

b. Unaccusative

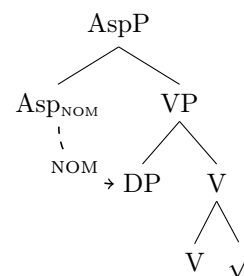

In the unergative (59a), Asp_{ERG} is merged with vP, and proceeds to assign ergative case to the external argument. The same process would occur in a transitive sentence. In the unaccusative (53b), a distinct Aspect head, Asp_{NOM} merges with VP, and proceeds to assign nominative case to the unaccusative subject

²⁰Note that only certain dialects are Split-S (Rezac et al. 2014).

within VP. In general, a structural model of the ergative case in Tlingit is also applicable, so long as we maintain that Aspect does not have an [EPP] feature, and that multiple distinct versions of the Aspect head exist in Tlingit.

6.2.3 Ergative is Assigned by Multiple Heads

Rather than proposing that the Tlingit ergative is singularly inherent or structural case, we could propose that it is instead some combination of both. In recent years, a new strand of theoretical work has begun to recognize the dual structural/inherent nature of ergative case in many of the world’s languages, specifically claiming that the ergative reflects a DP’s interaction with both the inflectional and verbal material. Perhaps most notable are Deal’s (2010) analysis of ergativity in Nez Perce, and Clem’s (2019) analysis of Amahuaca. On a broad scale, both analyses claim that ergative morphology on a DP results from agreement with multiple heads, specifically Tense and little *v* (Deal 2010, Clem 2019). An analysis along these lines may also be viable for ergative pronominal markers in Tlingit.

In particular, one could adopt a version of Deal’s (2010) analysis and argue that “ergative case” is not truly a case in a traditional sense – that is to say a case specifically assigned by a functional head. On the contrary, it is purely the reflection of a DP simultaneously being in an agreement relationship with a high inflectional head and little *v* (Deal 2010). This captures the insights of both structural and inherent theories of ergative case. From an inherent case standpoint, the licensing of ergative morphology on a DP is partly dependent on that DP being an external argument and establishing a spec-head agreement relationship with little *v*. From a structural case standpoint, ergative morphology is also dependent on the same DP agreeing with a higher inflectional head. Deal’s (2010) analysis specifically claims that ergative morphology on a DP results from agreement with a high inflectional head and a little *v* head *that has already agreed with an object lower in the structure*. This requirement of object agreement is built in to account for the fact that in Nez Perce, the ergative marker only appears on transitive subjects (Deal 2010).

Because Tlingit exhibits split-S alignment, with ergative pronominal markers also surfacing in intransitive unergatives, we could simply remove the requirement for object agreement on little *v* in adopting a Deal-style analysis. That is to say, ergative pronominal markers simply reflect agreement with the inflectional head Aspect and little *v*, regardless of whether or not little *v* has itself entered into an agreement relationship with an object. The following tree represents the agreement relations that would give rise to ergative pronominal markers in Tlingit in a Deal-style model.

(59) Agreement with Asp and little *v*

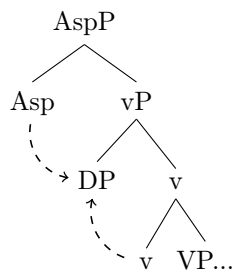

While the tree above represents the agreement operations that ergative pronominal markers in Tlingit would reflect, it says relatively little about how ergative pronominal markers specifically reflect this agreement within a DM-style architecture. To account for this, we could follow Deal (2010) further in assuming that DPs are passed onto the morphology with indices expressing which functional heads they have agreed with. That is to say, an external argument DP that has agreed with both little *v* and Asp in the syntax is passed to the morphology with the “features” [Asp] and [v]. When combined with the features for person and number, this would give rise to the following Vocabulary Items for ergative pronominal markers in Tlingit.

(60) Vocabulary Items for Ergative Markers

[+1,-pl, Asp, v]	->	/x̥a-/
[+2,-pl, Asp, v]	->	/i-/
[+1,+pl, Asp, v]	->	/tu-/
[+2,+pl, Asp, v]	->	/yi-/

Note that these Vocabulary Items are largely applicable pronominal markers regardless of whether or not they are argument DPs or clitics. They could indeed reflect true DPs, but if we adopt the “Big DP” analysis of clitics than they could also reflect features of a covert DP that are inherited by a clitic in a D position.

Ultimately, ergative markers are amenable to several different analyses with the limited set of evidence available right now, and further research is necessary to make a clear choice between these analyses. In most languages, a good starting point would be to observe the behavior of ergative markers in non-finite clauses, as the lack of a high inflectional head in these contexts would predict a loss of structural ergative case, but not inherent ergative case. Tlingit presents a particular challenge for this diagnostic, however, in that almost all subordinate clauses are fully specified for Aspect (Crippen, personal communication).

For whatever analysis works best, it is worth saying that the implementation of such an analysis may be applicable from a cross-linguistic standpoint. The pattern in Tlingit, whereby ergatives do not index external argument causees, is by no means unique. In fact, a lack of ERG-ERG configurations in constructions such as causatives is taken to be a linguistic universal by Nie (2016). This is likely indicative of a deeper underlying property of the ergative across the world’s languages. In this way, fully fleshing out the ergative in Tlingit may shed light on its true nature in a broad array of ergative languages.

Regardless of their underlying case properties, ergative pronominal markers within the verbal complex are not the only manifestation of ergativity in Tlingit. In the following section, I explore the unique properties associated with the ergative suffix *-ch*.

7 The Ergative Suffix *-ch* and its Relation to Pronominal Markers

Looking beyond pronominal markers, Tlingit also exhibits a system of ergative case alignment in the morphological marking of full DPs outside the verbal complex. As first discussed in Section 4, DPs that are transitive subjects are marked with the ergative suffix *-ch*, in opposition to intransitive subject and object DPs, which have no overt case morphology. Overall, the suffix of *-ch* exhibits a cluster of interesting properties, in that it does not behave like a traditional case-marker from a morphological standpoint, and in that its distribution does *not* follow the same split-S patterning as pronominal markers. I discuss both of these phenomena in this section, again providing potential syntactic analyses that can account for them. First, however, I provide an overview of *-ch*’s basic distributional properties.

7.1 The Distribution of *-ch*

On a broad level, *-ch* follows a basic ergative alignment pattern, in that it is used to mark transitive subjects, but not intransitive subjects or direct objects. This is distinct from the split-S alignment system of pronominal markers. The following examples, repeated from (39) demonstrate.

(61) Alignment Pattern of *-ch*

a. Transitive

(Crippen 2011:20)

Ax̥ éescch útlxi as.ée

ax̥ éesh-**ch** útlxi a- s- i
1SGPSS father-**ERG** soup 3ON3- CSV- cook
‘Father is cooking soup.’

- b. Unaccusative (Crippen 2011:23)

X'alchán yanéekw
X'alchán i- níkw
 X'alchán STV- sick
 'X'alchán is sick.'

- c. Unergative (Crippen 2011:20)

X'alchán woogoot
X'alchán wu- i- gut
 X'alchán PFV- STV- go
 'X'alchán went.'

In (61a), the transitive subject *éesh* 'father' is followed by *-ch*. This stands in contrast to the direct object in (61a) *útlxi* 'soup,' which has no overt case morphology, and the unaccusative subject *X'alchán* in (61b). Not also that in (61c), the *unergative* subject is also morphologically bare, therefore aligning with unaccusative subjects and direct objects in its case properties. In this way, the use of *-ch* does not reflect the same split-S alignment as pronominal markers, as all full DPs that are intransitive subjects lack *-ch*, regardless of whether they are unergative or unaccusative.

In addition to reflecting an alignment pattern different from split-S, two other distributional properties of *-ch* are worth noting. First, *-ch* fails to appear in reflexive constructions involving the anaphor *sh*. Second, *-ch* fails to appear on certain transitive subjects when the object belongs to a small category of "indefinite" nouns (Crippen 2011).

(62) Reflexives and Indefinite Nouns

- a. Reflexive (Crippen 2011:22)

X'alchán sh dzixán
X'alchán sh d- s- i- xán
 X'alchán REFL MID- CSV- STV- love
 'X'alchán loves himself.'

- b. Indefinite Object (Crippen 2011:22)

Ax éesh t'a awsit'éx
ax éesh t'a a- wu- s- i- t'ex
 1SG.PSS father king.salmon.INDEF 3ON3- PFV- CSV- STV- fish
 'My father was fishing for king salmon.'

7.1.1 The Morphological Distribution of *-ch*

Besides exhibiting an interesting syntactic distribution, *-ch* also has an interesting morphological distribution, distinct from that usually associated with traditional case markers. While it can be productively suffixed to lone DPs, as seen above, *-ch* can also be suffixed to structures larger than a single DP. For example, a single instance of *-ch* can mark whole coordinated phrases with two or more DPs (Crippen 2011).

- (63) *-ch* in Coordinated Phrases (Crippen 2011:21)

Séew ka gagaan kagánich áwé kei kanas.éin
 [séew ka gagaan kagán -i] **-ch** á -wé pro kei= ka- na- s- éin
 [rain and sun light -1SG.PSS] **-ERG** FOC- -MDST pro up= HSFC- NCNJ- CSV- grow
 'Rain and sunlight are making them (plants) grow.'

One might expect *-ch* to appear after both proper names in (63) if it were a case marker, and yet Crippen (2011) claims that he has seen no instance of that. In addition to this, *-ch* also appears after the plural clitic *has* when *has* co-occurs with a DP.

(64) Ergative after Plural Clitic *has* (Crippen 2011:21)

Du éesh hásch útlxi as.ée
 [du éesh =hás] -**ch** útlxi a- s- i
 [3h.pss father =PL] -**ERG** soup 3ON3- CSV- cook
 ‘His father and them are cooking soup’

For both of these reasons, Crippen (2011) claims that *-ch* is likely better analyzed as a clitic than a case suffix. In the section below, I examine the morphological status of *-ch* and its relationship to ergativity.

7.2 *-Ch* and the Adpositional Ergative Analysis

While one could indeed model *-ch* as a clitic, another promising analysis is to claim that it is a postposition with the category P, and therefore that ergative DPs marked with *-ch* really constitute PPs. This would nicely account for the distribution of *-ch*, and it would also fit well within a developing strand of analyses claiming that ergative “case” across many of the world’s languages is really adpositional in nature (Mahajan 1997b, Markman and Grashchenkov 2012, Polinsky 2016).

On a broad level, an adpositional analysis of the ergative essentially claims that ergative arguments are really PPs instead of DPs, and therefore that ergative morphology in many cases can be analyzed as an adposition belong to the category P (Mahajan 1997b, Markman and Grashchenkov 2012, Polinsky 2016). From a distributional standpoint, this analysis can easily account for the fact that *-ch* scopes over entire coordinate phrases, as this is a common behavior for adpositions (Polinsky 2016). Mahajan (1997b), for example, argues that the ergative marker *-ne* is a postposition on the grounds that – like Tlingit *-ch* – it too adjoins to coordinate phrases, as opposed to the individual DPs within them.

(65) *-ne* in Coordinated Phrases (Mahajan 1997a, via Polinsky 2016:37)

[laRki aur laRkaa] -*ne*
 [boy and girl] -ERG

Clearly, Mahajan’s (1997a) analysis can be extended to *-ch* on the exact same grounds. Moreover, if *-ch* is a postposition, one would also expect it to appear further from the DP than the plural clitic *has*, if we assume that *has*, like pronominal clitics, is generated relatively close to the DP within a “Big DP” structure. If we adopt a basic version of the adpositional analysis, we can therefore propose the following basic structure for ergative arguments in Tlingit.

(66) Structure of Ergative Arguments

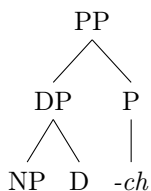

While an adpositional model of ergative morphology works well for *-ch* from a distributional standpoint, the actual theoretical details of the analysis certainly warrant being further fleshed out. While the proponents of this model all put forward the basic claim that ergative arguments are really PPs, they differ in their accounts of what the function of the ergative adposition is. Mahajan (1997b) straightforwardly claims that ergative adpositions such as *-ne* are realizations of dependent-case, adjoined to a DP when it c-commands another DP within a relevant domain. Markman and Grashchenkov (2012) propose that ergative adpositions

merge with a DP for theta-marking reasons. Specifically, they assume that in ergative languages little *v* fails to theta-mark subjects in its specifier, and therefore the adposition P_{ERG} is merged with that DP in order to theta-mark it. Finally, Polinsky (2016) proposes that little *v* in ergative languages does theta-mark arguments in its specifier, but that this occurs separately from case-assignment, which is instead carried out by an adposition.²¹ Adopting any of these analyses of the ergative adposition’s function has several numerous implications for the nature of the ergative in Tlingit. In the next section, I discuss which analysis works best, and how to account for the different alignment patterns between full DPs with *-ch* and pronominal markers.

7.3 Modeling the Ergative Properties of *-ch*

If we assume that the ergative suffix *-ch* is an adposition, an important next step is to fully delineate its role within the syntax, and to account for the fact that its distribution does *not* reflect the split-S alignment seen in pronominal markers. In this section I discuss a one potential analysis, which ultimately proposes that *-ch* is best modeled as an adposition that realizes dependent case along the lines of Mahajan (1997b). This particular analysis relies heavily on a functional difference between full DPs and pronominal markers, and thus fully assumes that pronominal markers are clitics.

7.3.1 *-ch* Reflects Dependent Case

Instead of proposing that *-ch* constitutes some kind of inherent or structural ergative case, as I did for pronominal markers, I argue instead that *-ch* is most straightforwardly modeled as a realization of dependent case (Marantz 1991, Baker 2015, Baker and Bobaljik 2017). Recall from Section 2 that dependent ergative case is assigned to a DP when it asymmetrically c-commands another DP within a certain domain (Marantz 1991, Baker 2015, Baker and Bobaljik 2017). This proposal easily accounts for the pattern in (61), repeated below.

(67) a. Transitive (Crippen 2011:20)

A \underline{x} éescch útlxi as.ée
*a \underline{x} éesh-**ch** útlxi a- s- i*
 1SGPSS father-**ERG** soup 3ON3- CSV- cook
 ‘Father is cooking soup.’

b. Unaccusative (Crippen 2011:23)

X’alchán yanéekw
X’alchán i- níkw
 X’alchán STV- sick
 ‘X’alchán is sick.’

c. Unergative (Crippen 2011:20)

X’alchán woogoot
X’alchán wu- i- gut
 X’alchán PFV- STV- go
 ‘X’alchán went.’

In the examples above, only the transitive subject, which c-commands another direct object DP, is marked with *-ch*, in contrast to both the unergative and unaccusative subject. This readily falls out from a dependent case theory, whereas an inherent case theory would have to stipulate a transitivity condition on little *v*, so as to account for the fact that unergatives are not marked with *-ch* (Woolford 2006, Legate 2012).

²¹Note that Polinsky (2016) adopts a PP ergative analysis as a means of explaining syntactic ergativity, something which does not fit with the purely morphologically ergative pattern of Tlingit. She ultimately claims, however, that not all PP ergative languages are required to exhibit syntactic ergativity (Polinsky 2016).

The dependent case account does face some initial challenges when constructions with reflexive anaphors and indefinite objects, as in (62), are taken into account. Looking at reflexives, if we assume that the anaphor *sh* is an anaphoric DP in an internal argument position, or a clitic generated by an anaphoric DP, we would expect the subject in a reflexive construction to exhibit dependent-case reflected by *-ch*, but it clearly does not.

The best way to account for this discrepancy is to propose that anaphors do not count towards the computation of dependent case assignment in the same way that R-expressions or pronouns do. This is not necessarily an ad hoc assumption, as there are numerous ways in which anaphors exhibit a different behavior than R-expressions or pronouns. One famous example is the inability of anaphors across many of the world’s languages to participate in verbal agreement relations (Rizzi 1990). Given the unique properties of anaphors when it comes to operations such as agreement, it is not unreasonable to expect that they would behave differently for dependent case assignment as well. Beyond this, however, several languages analyzed as having dependent ergative case also have absolutive subjects in reflexives. Baker and Bobaljik (2017) claim that Chukchi has dependent ergative, for example, in spite of the fact that subjects with reflexive objects are absolutive (Janic 2010).

As for indefinite nouns, we would have to make a similar assumption, also claiming that they do not count towards dependent case calculations. This proposal is admittedly much more stipulative than proposing that anaphors do not count, and ultimately the interaction between definiteness and case assignment needs to be further fleshed out in future work. It is worth noting, however, that an inherent ergative analysis cannot account for the lack of *-ch* with indefinite direct objects either. If inherent ergative case is assigned to a DP by a little *v* that gives it an external argument theta role, there is no reason to assume it would not be assigned based on the definiteness of the direct object.

In order to incorporate a dependent case analysis into an adpositional ergative analysis, I will fully adopt Mahajan (1997b)’s proposal, and model *-ch* in Tlingit as an adposition that realizes ergative case, which I label P_{ERG} . Thus we can model the assignment of dependent ergative in the following manner.

(68) a. Step 1: Dependent Case Assignment

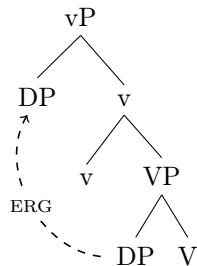

b. Step 2: P_{ERG} Adjoins to DP

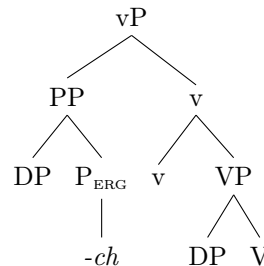

First, dependent ergative case is assigned to a DP that c-commands another DP. After this, a P head is adjoined to this DP, so as to serve as a syntactic and morphological realization of dependent case itself.

Ultimately a dependent ergative analysis models the distribution of the adposition *-ch* well, but it faces a few drawbacks. If one fully adopts a dependent case framework, proposing a dependent ergative case somewhat entails that the absolutive case in Tlingit is really a elsewhere case as opposed to a case assigned by a functional head (Marantz 1991, Baker 2015, Bobaljik 1993). While this is inconsistent with the analyses of absolutive case put forward in Section 5, it is worth saying that it is easily compatible with any analysis whereby absolutive case is really a morphological default. Beyond this, the dependent case analysis faces a major drawback in that it is completely distinct from the analyses proposed for ergative pronominal markers in Section 6. In the following section, I attempt to reconcile these two.

7.3.2 Two Types of “Ergative” in Tlingit

Ultimately, proposing that *-ch* reflects dependent case entails that the ergative case assigned to full DPs and the ergative case assigned to pronominal markers are radically different. While several tentative analyses for the ergative pronominal markers were put forward, none of them assume dependent case-assignment. From an empirical standpoint, this difference in case properties is well-motivated: pronominal markers clearly

reflect a split-S alignment, whereas DPs with *-ch* do not. It is worth asking, however, whether there is any way to integrate these two case modalities into a single model of Tlingit syntax.

One way to integrate these two modalities, which I outline here, is to assume that only one of them represents true case assignment, while the other reflects a completely different operation. This is feasible if we make two assumptions, the first being that ergative pronominal markers are clitics, and the second being that these clitics purely reflect *agreement* as opposed to case. Recall from Section 6 that Deal (2010) models ergative “case” as morphology reflecting a DP’s agreement with both a little *v* head and a high inflectional head. If we fully adopt this analysis for ergative pronominal clitics in Tlingit, we could propose that pronominal markers purely reflect agreement with little *v* and Asp, whereas the postposition *-ch* reflects dependent case assignment. In this way, case assignment and agreement are independent of one another in Tlingit, and there is only one true ergative “case,” which is a dependent case.

This proposal is advantageous in that it can completely account for the distribution of both pronominal markers and the postposition *-ch* without proposing that there are two distinct case assignment mechanisms in Tlingit. Pronominal ergative markers are clitics that realize a DP’s agreement with both Aspect and little *v*, and are therefore expected to index both transitive and unergative subjects introduced by a little *v* head. The postposition *-ch* realizes dependent case, and is thus only expected to appear on transitive subjects (under the assumption that anaphors and indefinite DPs do not count towards dependent case assignment). It should be noted that this proposal also does not claim that DPs themselves don’t participate in agree. Both Aspect and little *v* fully agree with a DP, but there are no overt morphological markers of this agreement on the DP itself. Instead, there are only overt morphological markers indicating these agreement features on the clitics that inherit them from the DP. The following trees demonstrate the mechanics of this model, first for an independent DP and then for a pronominal marker.

(69) Independent DP

a. Step 1: Agreement and Dependent Case Assignment

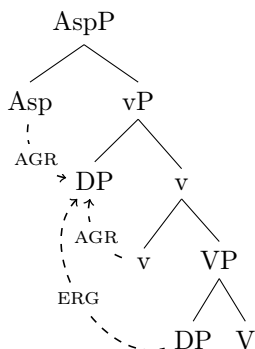

b. Step 2: P_{ERG} Adjoins to DP

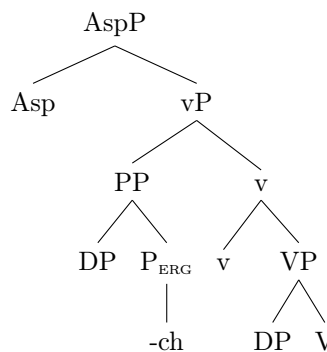

(70) Ergative Pronominal Marker

a. Step 1: Agreement and Dependent Case Assignment

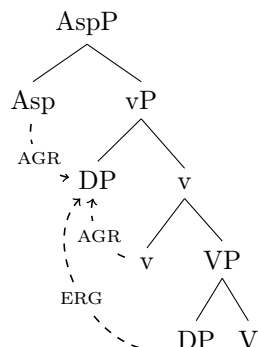

b. Step 2: Clitic Agreement

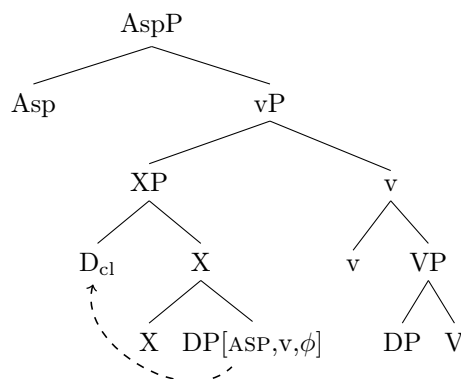

In both instances, dependent case assignment and agreement with Asp and little v occur. In (69), the 3rd person independent DP does not generate a clitic, and is indexed as having dependent ergative case through the postposition *-ch*. In (70), *pro* does generate a clitic, which inherits Aspect and little v agreement features, as well as ϕ features. Note that (69), in keeping with the idea that case assignment is separate from agreement with Asp and little v, also assumes that dependent-case is assigned to the *pro* DP. This requires adding several further stipulations. For one, we may have to posit that a postposition reflecting dependent ergative is also merged, but that it simply fails to show up overtly because the *pro* element is not overt. Second, and more importantly, maintaining case-assignment could mean that the DP may also have a dependent [ERG] case feature that it passes up to its clitic. As we have noted, however, pronominal clitics *do not* reflect a dependent-case pattern. One way to work around this is to propose that the Vocabulary Items for ergative pronominal clitics are unspecified for case features, and instead are only specified for agreement with Aspect and little v, thereby proposing the exact same Vocabulary Items first put forward in Section 6.2.3.

(71) Vocabulary Items for Ergative Clitics (Section 6.2.3)

[+1,-pl, Asp, v]	->	/x̄a-/
[+2,-pl, Asp, v]	->	/i-/
[+1,+pl, Asp, v]	->	/tu-/
[+2,+pl, Asp, v]	->	/yi-/

If the Vocabulary Items for ergative clitics are not specified for case features, we can maintain the fact that they are used for both transitive and unergative subjects. Both transitive and unergative subject DPs agree with Asp and little v, and can therefore pass those features up to a clitic. Transitive subjects may also pass up an [ERG] case feature, but because there are no specific Vocabulary Items with this feature, the same Vocabulary Items end up being inserted for both transitive and unergative subjects.

In general, the ergative suffix *-ch* exhibits morphological properties and alignment that are distinct from ergative pronominal markers. Analyzing these properties has important implications for both the cross-linguistic representation of ergative morphology, and the deeper syntactic nature of ergative case-assignment. Within Tlingit, the distribution of *-ch* is accounted for relatively well when it is modeled as an adposition, whose case assignment is different from the agreement indexing seen on pronominal markers. On a broad level, this is suggestive of the fact that the term “ergative” encompasses several operations beyond case assignment. Further fieldwork is needed to test the viability of this suggestion both within Tlingit and on a cross-linguistic scale.

8 Conclusion

In this thesis, I explored various dimensions of ergativity in Tlingit, specifically examining the nature of both the ergative and the absolutive case through the lens of pronominal markers and full DPs. Above all else, the issues and the analyses put forward throughout the essay demonstrate that ergativity is a complex and multifaceted phenomenon in Tlingit, complicated further by the fact that the syntactic status of pronominal markers and the verbal complex is somewhat unclear. If we abstract away from this complexity, there are several broad insights worth mentioning. From the standpoint of modeling ergativity in Tlingit, it is somewhat clear that a clitic doubling analysis of pronominal markers may offer more flexibility than an argument analysis. For one, it allows the position of absolutive markers to be distinct from their case properties. Additionally, it offers us an easier way to account for the different alignment systems demonstrated independent nominals and ergative pronominal markers, as clitics ultimately do not have to reflect the same morphosyntactic features as full DPs. Building off of this, it is also clear that analyzing ergative “case” as the realization of agreement with multiple heads allows for a good degree of flexibility as well. It can account for the mixed structural-inherent case properties of ergative pronominals, and can account for the difference between the adposition *-ch* and pronominal markers without resorting to two case modalities.

Focusing on the Tlingit language itself, two other insights are worth putting forward. First, in spite of the fact that absolutive markers appear close to the high inflectional head Aspect, it seems quite unlikely that the absolutive is akin to the nominative in Tlingit. Numerous analyses predict that licensing absolutive case from a high inflectional head should lead to syntactic ergativity (Coon et al. 2014, Assmann et al. 2015), yet this does not occur in Tlingit. In modeling the nature of absolutive markers, this ultimately suggests that their movement properties are quite distinct from their case properties. Second, the ergative associated with pronominal markers, regardless of whether it is inherent, structural, or simply a reflection of agreement with multiple heads, is quite distinct from the ergative associated with independent DPs. From a syntactic standpoint, this is broadly indicative of the fact that ergative “case” is likely a multivariate phenomenon in Tlingit. From a cross-linguistic standpoint, this may suggest that ergative morphology is a manifestation of several distinct phenomena that cannot be simply reduced to case assignment.

Ultimately, the properties of case-alignment in Tlingit are fertile ground for future research. Given the limited set of data, the phenomena discussed in this essay have numerous potential explanations. Narrowing down these explanations requires further fieldwork, thus reinforcing the importance of continued, theoretically-driven fieldwork on both underdocumented and endangered languages.

References

- Aldai, Gontzal. 2009. Is Basque morphologically ergative? Western Basque vs. Eastern Basque. *Studies in Language* 33:783–831.
- Aldridge, Edith. 2004. Ergativity and Word Order in Austronesian Languages. Phd dissertation, Cornell University, Ithaca, NY.
- Aldridge, Edith. 2008. Minimalist Analysis of Ergativity. *Sophia Linguistica* 55:123–142.
- Anttila, Arto. 2016. Phonological Effects on Syntactic Variation. *Annual Review of Linguistics* 2:115–137.
- Arregi, Karlos, and Andrew Nevins. 2012. *Morphotactics: Basque Auxiliaries and the Structure of Spellout*. Dordrecht, Netherlands: Springer.
- Assmann, Anke, Doreen Georgi, Fabian Heck, Gereon Müller, and Philipp Weisser. 2015. Ergatives Move Too Early: On an Instance of Opacity in Syntax. *Syntax* 18:343–387.
- Baker, Mark. 2015. *Case: Its Principles and Parameters*. Cambridge, UK: Cambridge University Press.
- Baker, Mark, and Jonathan David Bobaljik. 2017. On Inherent and Dependent Theories of Ergative Case. In *The Oxford Handbook of Ergativity*, ed. Jessica Coon, Diane Massam, and Lisa Travis, 111–134. Oxford: Oxford University Press.
- Bittner, Maria. 1994. *Case, Scope and Binding*. Dordrecht, Netherlands: Kluwer.
- Bittner, Maria, and Ken Hale. 1996. Ergativity: Toward a Theory of a Heterogeneous Class. *Linguistic Inquiry* 27:531–604.
- Bobaljik, Jonathan David. 1993. Ergativity and Ergative Unergatives. In *Papers on Case and Agreement II*, ed. Collin Phillips, 45–88. Cambridge, MA: MIT Working Papers in Linguistics.
- Bok-Bennema, Reineke. 1991. *Case and Agreement in Inuit*. Dordrecht, Netherlands: Foris.
- Cable, Seth. 2007. The Grammar of Q: Q-Particles and the Nature of Wh-Fronting, As Revealed by the Wh-Questions of Tlingit. Doctoral dissertation, Massachusetts Institute of Technology, Cambridge, MA.
- Cable, Seth. 2008. Covert A-Scrambling in Tlingit. In *Proceedings of the 43rd International Conference on Salish and Neighboring Languages*, ed. C. Christodolou and J. Lyon, 22–53. Vancouver, BC: University of British Columbia Working Papers in Linguistics.
- Cable, Seth. 2018. Expressing Generalities in Tlingit: Imperfective Mode vs. Habitual Mode (With a Few Notes on the Ergative Postposition). Ms, University of Massachusetts Amherst.
- Campana, Mark. 1992. A Movement Theory of Ergativity. PhD Dissertation, McGill University, Montréal, Canada.
- Chomsky, Noam. 1981. *Lectures on Government and Binding*. Dordrecht, Netherlands: Foris.
- Chomsky, Noam. 1995. *The Minimalist Program*. Cambridge, MA: MIT Press.
- Chomsky, Noam. 2000. Minimalist Inquiries. In *Step by Step: Essays on Minimalist syntax in Honor of Howard Lasnik*, ed. Roger Martin, David Michaels, and Juan Uriagareka, 89–156. Cambridge, MA: MIT Press.
- Chomsky, Noam. 2004. Beyond Explanatory Adequacy. In *Structures and Beyond*, ed. Adriana Belletti, 104–131. Oxford, UK: Oxford University Press.
- Clem, Emily. 2019. Amahuaca ergative as agreement with multiple heads. *Natural Language and Linguistic Theory* 37:785–823.
- Coon, Jessica. 2010. Complementation in Chol (Mayan): A theory of split ergativity. PhD Dissertation, Massachusetts Institute of Technology, Cambridge, MA.
- Coon, Jessica, Pedro Mateo Pedro, and Omer Preminger. 2014. The role of case in A-bar extraction asymmetries: Evidence from Mayan. *Linguistic Variation* 14:179–242.
- Coon, Jessica, and Omer Preminger. 2012. Towards a Unified Account of Person Splits. In *Proceedings of the 29th West Coast Conference on Formal Linguistics*, ed. Jaehoon Choi, E. Alan Hogue, Jeffrey Punske, Deniz Tat, Jessamyn Schertz, and Alex Trueman, 310–318. Somerville, MA: Cascadilla Proceedings Project.
- Crippen, James. 2011. The Basics of Tlingit Verbal Structure. Ms, Vancouver, BC.
- Crippen, James. 2012. Exploring Tlingit relative clauses: Morphology and syntax. Ms, Vancouver, BC.
- Crippen, James. 2013. Tlingit Verbal Structure Handbook. Ms, Vancouver, BC.
- Crippen, James. 2019. The Syntax in Tlingit Verbs. PhD Dissertation, University of British Columbia, Vancouver, BC.

- Crippen, James, and Rose Marie Déchaine. 2015. Syntax and semantics of the Tlingit classifier. In *Proceedings of the WSCLA 20*, ed. Emily Sadlier-Brown, Erin Guntly, and Natalie Weber. Vancouver, BC: University of British Columbia.
- Deal, Amy Rose. 2010. Ergative case and the transitive subject: a view from Nez Perce. *Natural Language and Linguistic Theory* 28:73–120.
- Deal, Amy Rose. 2016. Syntactic Ergativity: Analysis and Identification. *Annual Review of Linguistics* 2:165–185.
- DeLancey, Scott. 1981. An Interpretation of Split Ergativity and Related Patterns. *Language* 57:626–657.
- Dixon, R.M.W. 1972. *The Dyirbal Language of North Queensland*. Cambridge, UK: Cambridge University Press.
- Dixon, R.M.W. 1979. Ergativity. *Language* 55:59–138.
- Dixon, R.M.W. 1994. *Ergativity*. Cambridge, UK: Cambridge University Press.
- Eggleston, Keri. 2013. 575 Tlingit verbs: A study of Tlingit verb paradigms. PhD Dissertation, University of Alaska Fairbanks, Fairbanks, AK.
- Friend, Robyn. 1985. Some Syntactic and Morphological Features of Suleimaniye Kurdish. Doctoral dissertation, University of California, Los Angeles, Los Angeles, CA.
- Halle, Morris, and Alec Marantz. 1993. Distributed Morphology and the Pieces of Inflection. In *The View from Building 20*, ed. Kenneth Hale and S. Jay Keyser, 111–176. Cambridge, MA: MIT Press.
- Halle, Morris, and Alec Marantz. 1994. Some Key Features of Distributed Morphology. In *Papers on Phonology and Morphology*, ed. Andrew Carnie and Heidi Harley, 275–288. Cambridge, MA: MIT Press.
- Hamp, Eric, and Christine Chiarello. 1979. Tongass Tlingit and Na-Dene. In *Proceedings of the 5th Annual Meeting of the Berkeley Linguistics Society*, 461–470. Berkeley, CA: Berkeley Linguistics Society.
- Ippolito, Michela. 2000. Remarks on the argument structure of Romance causatives. Ms.
- Janic, Katarzyna. 2010. On the Reflexive-Antipassive Polysemy: Typological Convergence from Unrelated Languages. In *Proceedings of the 36th Annual Meeting of the Berkeley Linguistics Society*, ed. Nicholas Rolle, Jeremy Steffman, and John Sylak-Glassman, 158–173. Berkeley, CA: Berkeley Linguistics Society.
- Jelinek, Eloise. 1984. Empty Categories, Case and Configurationality. *Natural Language and Linguistic Theory* 2:39–76.
- Keenan, Edward, and Bernard Comrie. 1977. Noun Phrase Accessibility and Universal Grammar. *Linguistic Inquiry* 8:63–99.
- Kim, Kyumin. 2011. High applicatives in Korean causatives and passives. *Lingua* 121:487–510.
- van Koppen, Marjo, and Jeroen van Craenenbroeck. 2008. Pronominal Doubling in Dutch Dialects: Big DPs and Coordinations. In *Microvariation in Syntactic Doubling*, ed. Sjef Barbiers, Olaf Koenenman, Marika Lekakou, and Margreet van der Ham, 207–249. Bingley, UK: Emerald.
- Kratzer, Angelika. 1996. Severing the external argument from its verb. In *Phrase Structure and the Lexicon*, ed. J Rooryk and L Zaring, number 33 in Studies in Natural Language and Linguistic Theory, 109–137. Dordrecht: Springer.
- Krauss, Michael. 1964. Proto-Athapaskan-Eyak and the Problem of Na Dene: The Phonology. *International Journal of American Linguistics* 30:118–131.
- Krauss, Michael. 1965. Proto-Athapaskan-Eyak and the Problem of Na-Dene II: Morphology. *International Journal of American Linguistics* 31:18–28.
- Krauss, Michael. 1973. Na-Dene. In *Linguistics in North America*, ed. Thomas Sebeok, 903–978. The Hague, Netherlands: Mouton de Gruyter.
- Laka, Itziar. 2006. Deriving Split Ergativity in the Progressive. In *Ergativity: Emerging Issues*, ed. Diane Massam, Alana Johns, and Juvenal Ndayiragije, 173–196. Dordrecht, Netherlands: Springer.
- Leer, Jeff. 1989. Directional Systems in Athapaskan and Na-Dene. In *Athapaskan Linguistics: Current Perspectives on a Language Family*, ed. Eung-Do Cook and Keren Rice, 575–622. Berlin, Germany: Mouton de Gruyter.
- Leer, Jeff. 1991. The Schetic Categories of the Tlingit Verb. PhD Dissertation, University of Chicago, Chicago, IL.
- Leer, Jeff. 2008. Recent Advances in AET Comparison. Ms, Alaska Native Language Archive.

- Legate, Julie Anne. 2006. Split Absolutive. In *Ergativity: Emerging Issues*, ed. Alana Johns, Diane Massam, and Juvenal Ndayiragije, 143–172. Dordrecht, Netherlands: Springer.
- Legate, Julie Anne. 2008. Morphological and Abstract Case. *Linguistic Inquiry* 39:55–101.
- Legate, Julie Anne. 2012. Types of Ergativity. *Lingua* 122:181–191.
- Mahajan, Anoop. 1997a. Rightward Scrambling. In *Rightward Movement*, ed. Dorothee Beerman, David LeBlanc, and Henk van Riemsdijk, 186–214. Amsterdam, Netherlands: John Benjamins.
- Mahajan, Anoop. 1997b. Universal Grammar and the Typology of Ergative Languages. In *Studies on Universal Grammar and Typological Variation*, ed. Artemis Alexiadou and Tracy Hall, 35–57. Amsterdam, Netherlands: John Benjamins.
- Marantz, Alec. 1991. Case and Licensing. In *Proceedings of the Eight Eastern States Conference on Linguistics*, ed. German Westphal, Benjamin Ao, and Chae Hee-Rhak, 234–253. Columbus, OH: Ohio State University.
- Markman, Vita, and Pavel Grashchenkov. 2012. On the Adpositional Nature of Ergative Subjects. *Lingua* 122:257–266.
- Massam, Diane. 2009. The Structure of (Un)ergatives. In *Proceedings of the Sixteenth Meeting of the Austronesian Formal Linguistics Association*, ed. Sandra Chung, Daniel Finer, Ileana Paul, and Eric Potsdam, 125–135. Santa Cruz, CA: UCSC.
- Miller, Philip, Geoffrey Pullum, and Arnold Zwicky. 1997. The Principle of Phonology Free-Syntax: Four Apparent Counterexamples in French. *Journal of Linguistics* 33:67–90.
- Murasugi, Kumiko. 1992. Crossing and Nested Paths: NP Movement in Accusative and Ergative Languages. PhD Dissertation, Massachusetts Institute of Technology, Cambridge, MA.
- Nevins, Andrew. 2011. Multiple Agree with Clitics: Person Complementarity vs. Omnivorous Number. *Natural Language and Linguistic Theory* 29:939–971.
- Nichols, Johanna. 1986. Head-marking and dependent-marking grammar. *Language* 62:56–119.
- Nie, Yining. 2016. Why is there nom-nom but no erg-erg. *Toronto Working Papers in Linguistics* 36.
- Polinsky, Maria. 2015. Tsez syntax: A description. Ms, Harvard University.
- Polinsky, Maria. 2016. *Deconstructing Ergativity: Two Types of Ergative Languages and Their Features*. Oxford, UK: Oxford University Press.
- Pylkkanen, Liina. 2002. Introducing Arguments. PhD Dissertation, Massachusetts Institute of Technology, Cambridge, MA.
- Pylkkanen, Liina. 2008. *Introducing Arguments*. Cambridge, MA: MIT Press.
- Rezac, Milan, Pablo Albizu, and Ricardo Etxepare. 2014. The structural ergative of Basque and the theory of Case. *Natural Language and Linguistic Theory* 32:1273–1330.
- Rizzi, Luigi. 1990. On the Anaphor Agreement Effect. *Rivista di Linguistica* 2:27–42.
- Savescu-Ciucivara, Oana. 2009. A Syntactic Analysis of Pronominal Clitic Clusters in Romance: The View from Romanian. PhD Dissertation, New York University, New York, NY.
- Tollan, Rebecca. 2018. Unergatives are Different: Two Types of Transitivity in Samoan. *Glossa: A Journal of General Linguistics* 35:1–41.
- Torrego, Esther. 1992. Case and Agreement Structure. Ms, University of Massachusetts Boston.
- Uriagareka, Juan. 1995. Aspects of the Syntax of Clitic Placement in Western Romance. *Linguistic Inquiry* 26:79–123.
- Watters, David. 1973. Clause patterns in Kham. In *Clause, sentence, and discourse patterns in selected languages of Nepal*, ed. Austin Hale, 39–202. Norman, Oklahoma: SIL.
- Wiltschko, Martina. 2006. On ‘Ergativity’ in Halkomelem Salish. In *Ergativity: Emerging issues*, ed. Diane Massam, Alana Johns, and Juvenal Ndayiragije, 197–227. Dordrecht, Netherlands: Springer.
- Woolford, Ellen. 1997. Four-Way Case Systems: Ergative, Nominative, Objective and Accusative. *Natural Language and Linguistic Theory* 15:181–227.
- Woolford, Ellen. 2006. Lexical Case, Inherent Case, and Argument Structure. *Linguistic Inquiry* 37:111–130.
- Zwicky, Arnold, and Geoffrey Pullum. 1983. Cliticization vs. Inflection: English *n't*. *Language* 59:502–513.
- Zwicky, Arnold, and Geoffrey Pullum. 1986. The Principle of Phonology-Free Syntax: Introductory Remarks. *Ohio State University Working Papers in Linguistics* 32:63–91.